

# Tian Song<sup>®</sup>



## 浙江天松医疗器械股份有限公司

Zhejiang Tiansong Medical Instrument Co., Ltd.

(原杭州桐庐尖端内窥镜有限公司)  
Hangzhou Tonglu Acme Endoscope Co., Ltd.



### 泌尿外科 · 普外科 · 妇科

### UROLOGY · SURGERY · GYNECOLOGY



通过ISO9001、ISO13485认证  
通过欧盟CE认证、美国FDA认证

股票简称：天松医疗  
股票代码：430588



2017年4月第一版

浙江天松医疗器械股份有限公司创建于1998年，是一家专业从事内窥镜及微创医疗器械研发、生产、销售和服务的国家火炬计划重点高新技术企业，于2014年1月挂牌上市！

公司拥有省级高新技术企业研究开发中心，是浙江省医疗器械产业技术创新战略联盟理事长单位，成为行业内产品序列最为完备的制造企业之一。“天松牌医用内窥镜”在2007年被评为“中国名牌产品”。2015年“天松医疗”获省级重点企业研究院。

公司先后通过了ISO9001及ISO13485国际质量体系认证、欧盟CE、美国FDA，其产品可广泛应用于耳鼻喉科、腹部外科、泌尿肛肠外科、骨科、妇产科、胸腔心血管外科、神经外科等主要科室的临床诊断和微创治疗，并远销美国、德国、日本、印度等三十多个国家和地区。



董事长 徐天松

浙江省医疗器械行业协会副会长

## COMPANY PROFILE

Zhejiang Tiansong Medical Instrument Co.,Ltd was founded in 1998. It is a National Torch Plan and new high-tech enterprise which engages in research and development, manufacturing, sales and service of medical endoscope and instruments. The company listed its shares in January 2014.

We have provincial high-tech enterprise research and development center, and we are the provincial key enterprise institute. We are the president unit of the medical equipment industry in Zhejiang province technology innovation strategic alliance. We become one of the most complete medical products manufacturers in the industry. "Tian Song brand medical endoscope" is awarded as "China Top Brand" in 2007. "Tian Song medical" won the Provincial key enterprise institute in 2015.

We passed the ISO9001, ISO13485, CE and FDA. The product range covers ENT, Surgery, Gynecology, Urology, Orthopedics, Thoracic surgery, Neurosurgery etc. The products are sold to more than 30 countries and regions such as USA, Germany, Japan, India etc.

厂区-1



厂区-2-内景



厂区-2







选用瑞典生产的“山特维克”优质不锈钢材料和先进的生产设备，二十多年的生产经验，承接传统精湛的工艺，共同打造尖端产品，尽展现代尖端科技。

行业领先的数控装备，提供最先进的加工技术  
A corner of Workshop equipped with numerical controlled machines showing its production capability



瑞士威力铭马科戴尔五轴联动数控加工中心加工内窥镜及手术钳精密零件  
5Axes CNC Machine made in WILLEMIN-MACODEL S.A./Switzerland for high precision mechanical parts production

德国巨浪 (Chiron) 复合加工中心实现高速、高效、高精度柔性加工  
Compound CNC machine from Chiron Germany for fast, efficient and high precision production in wide range of flexibility



光学车间德国工程师指导生产  
German engineer guides production in the optical workshop

尖端科技 尖端产品 尖端服务  
*Top Technology Top Products Top Service*

# CONTENTS

## 目录

泌尿外科·普外科·妇科

UROLOGY·SURGERY·GYNECOLOGY

泌尿外科	UROLOGY	
NP-6尿道膀胱镜	Urethro-cystoscopy set	01
NP-7尿道膀胱镜	Urethro-cystoscopy set	02
NP-2型小儿尿道膀胱镜	Pediatric cystoscopy set	03
NQ-3型尿道切开器	Urethrotomy set	04
DQ-4型电切镜	Resectoscopy set	05
DQ-7型电切镜	Resectoscopy set	06
DQ-8型电切镜	Resectoscopy set	09
DQ-10型电切镜	Resectoscopy set	08
DQ-9型小儿电切镜	Pediatric resectoscopy set	09
PS-3/PS-4型膀胱碎石镜	Lithotripsy set	10
SS-3型输尿管肾镜	Ureterorenoscopy set	11
泌尿外科手术器械选购件	Urology instruments options	12
普外科	SURGERY	
腹腔镜手术器械	Laparoscopy instruments	15
甲状腺手术器械	Thyroid instruments	26
腹腔镜单孔经济器械	Single-hole n umbilical laparoscopy instruments	26
腹腔镜经济器械(弯型)	N umbilical laparoscopy instruments(curved)	27
微型腹腔镜手术器械	Mini laparoscopy instruments	28
小切口器械	Small incision instruments	28
胸腔镜手术器械	Thoracoscopy instruments	29
高频线	High frequency cord	33
ZCX型自动冲洗吸引泵	Automatic suction and rinsing apparatus	34

肛肠科	ANS-ENTEROLGY	
CJ-1/CJ-2/CJ-3乙状镜、直肠镜	Sigmoidoscopy & resectoscopy set	35
妇科	GYNECOLOGY	
GQ-6型宫腔镜	Hysteroscopy set	36
GQ-3型宫腔镜	Hysteroscopy set	37
GQ-8型宫腔镜(检查)	Hysteroscopy set(examine)	37
GQ-10型宫腔镜(检查)	Hysteroscopy set(examine)	38
GQ-11型宫腔镜	Hysteroscopy set	38
GQ-12型宫腔镜	Hysteroscopy set	39
GQ-15/GQ-16型宫腔镜	Hysteroscopy set	40
DQ-5型电切镜(宫腔)	Resectoscopy set(Hysteroscopy)	41
电动子宫切割器	Electric hystera-cutter	42
妇科手术器械	Gynecology instruments	43
附属设备	ACCESSORIES	
内窥镜图像显示仪	Endoscopy camera system	46
监视器	Camera system, Coupler, Cold light source	47
摄像机/光学接口/冷光源	Surveillance monitor	48
导光束/连接器/附属设备	Light guide cable, Adaptor, Accessories	49
消毒盒	Sterilize box	50



本公司可为用户加工各种光学镜片和定制特殊器械，维修各国硬管内窥镜。

NP-6尿道膀胱镜 (插口式) Urethro-cystoscopy set (Click)

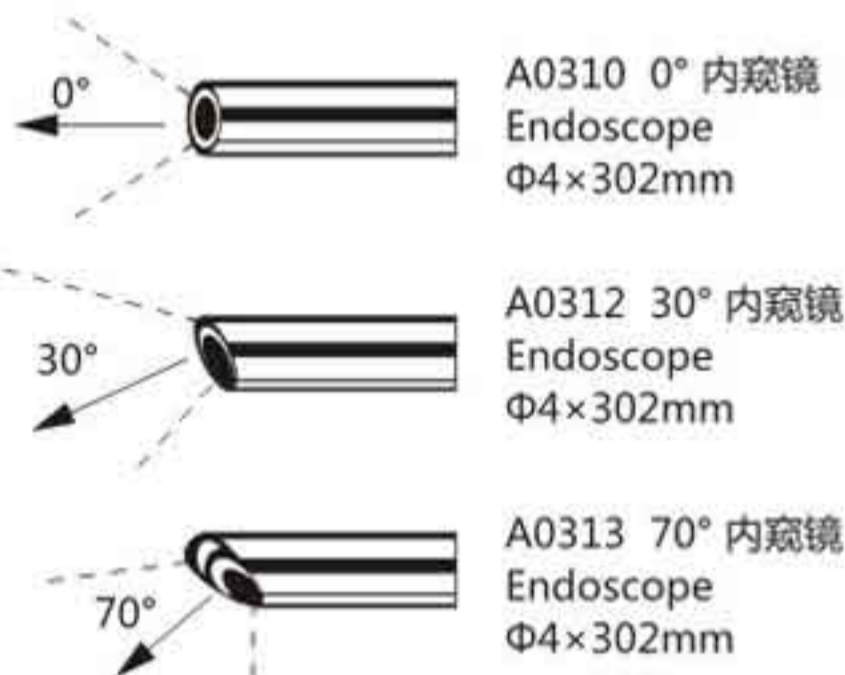

- 1. 连接天松导光束  
连接OLYMPUS导光束  
连接STORZ导光束
- 2. 连接WOLF导光束
- 3. 连接ACMI STRYKER导光束

- 1. Connecting to TIANSONG light guide cable  
Connecting to OLYMPUS light guide cable  
Connecting to STORZ light guide cable
- 2. Connecting to WOLF light guide cable
- 3. Connecting to ACMI, STRYKER light guide cable



T1001连接器 Adaptor



T1009.1 进水阀门  
Luer-lock adaptor



A2145 密封帽 sealing cap

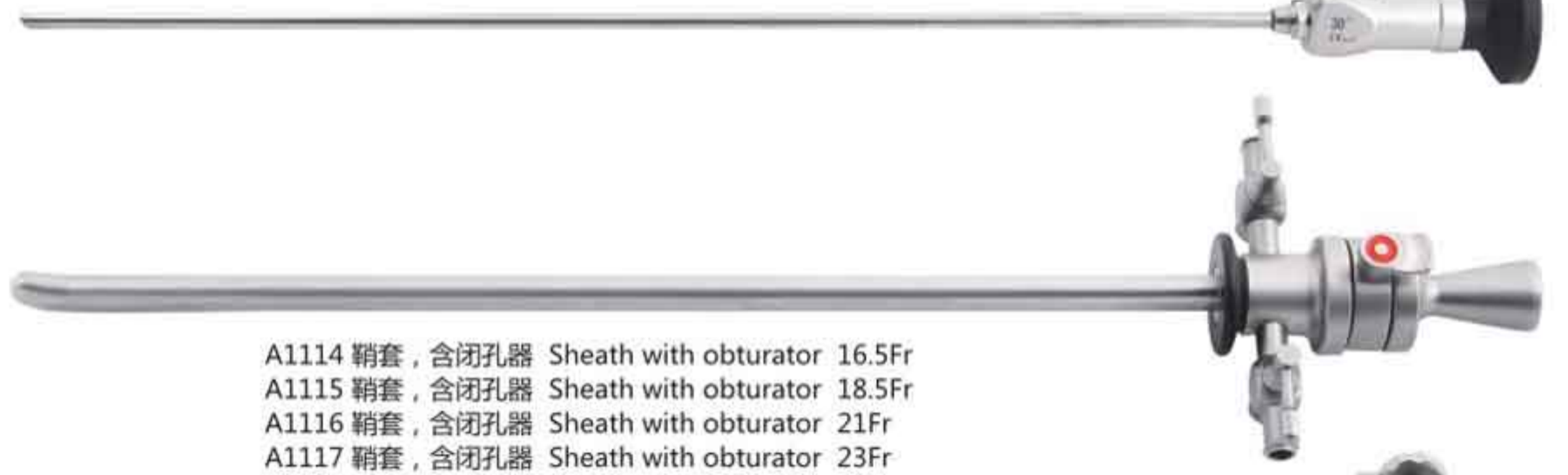

- A1114 鞘套, 含闭孔器 Sheath with obturator 16.5Fr
- A1115 鞘套, 含闭孔器 Sheath with obturator 18.5Fr
- A1116 鞘套, 含闭孔器 Sheath with obturator 21Fr
- A1117 鞘套, 含闭孔器 Sheath with obturator 23Fr

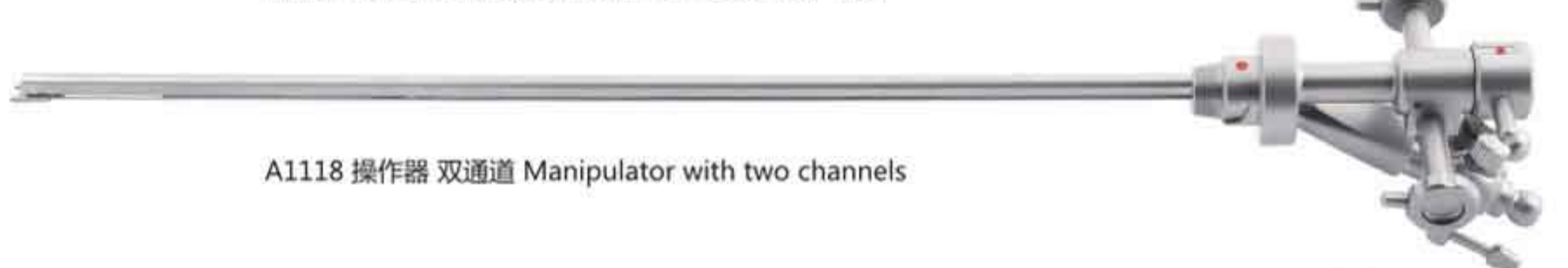

A1118 操作器 双通道 Manipulator with two channels



A4010 清洗杆 Cleaning bar  $\Phi 3 \times 340\text{mm}$



T5010 导光束 Light guide cable  
 $\Phi 4.5 \times 2000\text{mm}$



A1119 窥镜桥 (单通道)  
Endoscope bridge(single channel)



A1119.1 窥镜桥 (双通道)  
Endoscope bridge(Double channel)



A1119.2 窥镜桥 (无水阀)  
Endoscope bridge(without valve)



内窥镜软钳 Endoscopy flexible forceps 7Fr $\times$ 395mm



A2101 活检状  
Biopsy forceps



A2102 异物状  
Foreign body forceps



A2103 锯齿状  
Serrated forceps



A2104 剪状  
Scissors





Top Technology  
Top Products  
Top Service



尖端科技  
尖端产品  
尖端服务

[02]

## NP-7尿道膀胱镜 (锁口式) Urethro-cystoscopy set (Lockable)

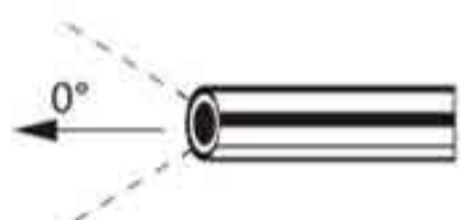

A0010 0° 内窥镜  
Endoscope  
Φ4×302mm



A0012 30° 内窥镜  
Endoscope  
Φ4×302mm

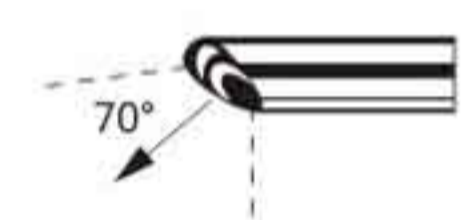

A0013 70° 内窥镜  
Endoscope  
Φ4×302mm



T1001 连接器 Adaptor



T1009.1 进水阀门  
Luer-lock adaptor



A2145 密封帽 sealing cap



T5010 导光束 Light guide cable  
Φ4.5×2000mm

1. 连接天松导光束  
连接OLYMPUS导光束  
连接STORZ导光束
2. 连接WOLF导光束
3. 连接ACMI STRYKER导光束

1. Connecting to TIANSONG light guide cable  
Connecting to OLYMPUS light guide cable  
Connecting to STORZ light guide cable
2. Connecting to WOLF light guide cable
3. Connecting to ACMI, STRYKER light guide cable

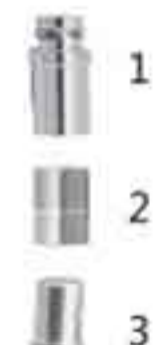

A1101.1 鞘套, 含闭孔器 Sheath with obturator 16.5Fr  
A1102.1 鞘套, 含闭孔器 Sheath with obturator 18.5Fr  
A1103.1 鞘套, 含闭孔器 Sheath with obturator 21Fr  
A1104.1 鞘套, 含闭孔器 Sheath with obturator 23Fr



A1105.1 操作器 双通道 Manipulator with two channels

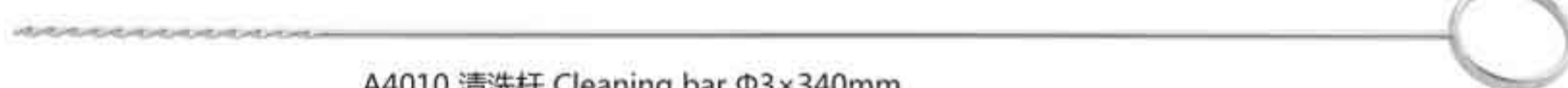

A4010 清洗杆 Cleaning bar Φ3×340mm



A1106.1 窥镜桥 (单通道)  
Endoscope bridge(single channel)



A1106.2 窥镜桥 (双通道)  
Endoscope bridge(Double channel)



A1106.3 窥镜桥 (无水阀)  
Endoscope bridge(without valve)

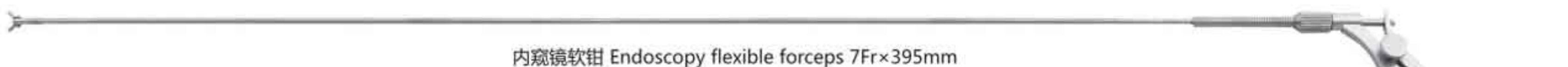

内窥镜软钳 Endoscopy flexible forceps 7Fr×395mm



A2101 活检状  
Biopsy forceps



A2102 异物状  
Foreign body forceps



A2103 锯齿状  
Serrated forceps



A2104 剪状  
Scissors



NP-2型小儿尿道膀胱镜 (锁口式) Pediatric cystoscopy set (Lockable)



A0210 0° 内窥镜  
Endoscope  
Φ2.7×205mm



A0211 30° 内窥镜  
Endoscope  
Φ2.7×205mm



T1001 连接器 Adaptor



T1009.1 进水阀门  
Luer-lock adaptor



A2145 密封帽 Sealing cap



T5010 导光束 Light guide cable  
Φ4.5×2000mm

1. 连接天松导光束  
连接OLYMPUS导光束  
连接STORZ导光束
2. 连接WOLF导光束
3. 连接ACMI STRYKER导光束

1. Connecting to TIANSONG light guide cable  
Connecting to OLYMPUS light guide cable  
Connecting to STORZ light guide cable
2. Connecting to WOLF light guide cable
3. Connecting to ACMI, STRYKER light guide cable



A1201 鞘套, 含闭孔器 Sheath with obturator 11Fr  
A1202 鞘套, 含闭孔器 Sheath with obturator 13.5Fr



A 1203 操作器 Manipulator



A1204 窥镜桥 Endoscope bridge



内窥镜软钳 Endoscopy flexible forceps 5.5Fr×260mm



A2201 活检状  
Biopsy forceps



A2202 锯齿状  
Serrated forceps



A2203 异物状  
Foreign body forceps



Top Technology  
Top Products  
Top Service



尖端科技  
尖端产品  
尖端服务

[04]

## NQ-3型尿道切开镜 (锁口式) Urethrotomy set (Lockable)

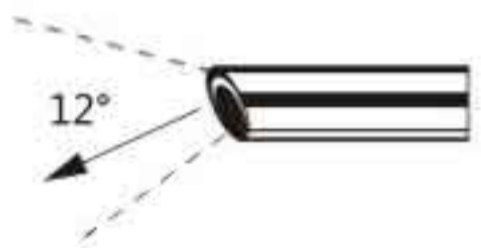

A0011 12° 内窥镜  
Endoscope  
Φ4×302mm

1. 连接天松导光束  
连接OLYMPUS导光束  
连接STORZ导光束
2. 连接WOLF导光束
3. 连接ACMI STRYKER导光束

1. Connecting to TIANSONG light guide cable  
Connecting to OLYMPUS light guide cable  
Connecting to STORZ light guide cable
2. Connecting to WOLF light guide cable
3. Connecting to ACMI, STRYKER light guide cable

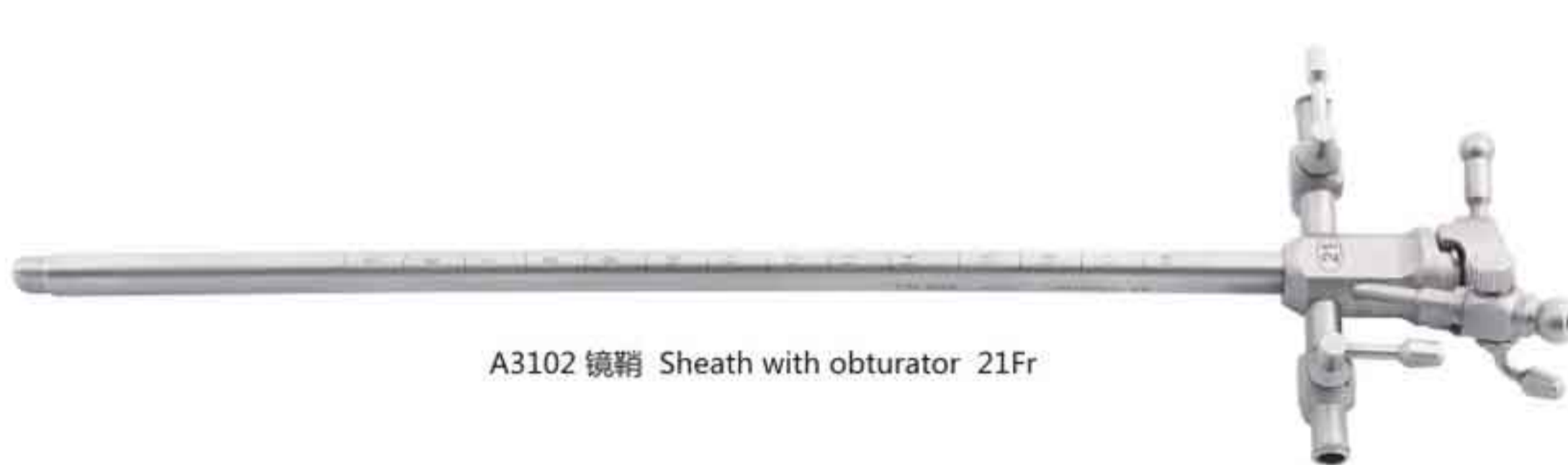

A3102 镜鞘 Sheath with obturator 21Fr



A3101 切开器 (被动式) Working element (passive)



A3103 镜鞘附加器 Supplementary sheath



刀具 Cold knife



A3104 柳叶刀状 Lancet



A3105 半圆刀状 Half-round knife



A3106 钩状刀状 Hook shape knife



T1001 连接器 Adaptor



T1009.1 进水阀门  
Luer-lock adaptor



A2145 密封帽 Sealing cap



T5010 导光束 Light guide cable  
Φ4.5×2000mm

DQ-4型电切镜 (锁口式) Resectoscopy set (Lockable)



A0012 30° 内窥镜  
Endoscope  
Φ4×302mm

1. 连接天松导光束  
连接OLYMPUS导光束  
连接STORZ导光束
2. 连接WOLF导光束
3. 连接ACMI STRYKER导光束

1. Connecting to TIANSONG light guide cable  
Connecting to OLYMPUS light guide cable  
Connecting to STORZ light guide cable
2. Connecting to WOLF light guide cable
3. Connecting to ACMI, STRYKER light guide cable



A3165.3S 外鞘 Outer sheath 26.5Fr

A3163.3S 内鞘, 含闭孔器  
Inner sheath with obturator 24.5Fr



A3160.4S 工作把手 (被动式)  
Working element (Passive)



手术电极 Electrode



1.3-DS-24环状  
Loop 30°



4-DS-24滚状  
Roller



5-DS-24齿状  
Spike



3.1-DS-24铲状  
Spud 30°



M1015 高频线 (单极)  
High frequency cord (Monopolar)



T4002 手动冲吸器 (艾利克式)  
Evacuator(Ellik)  
T1001.6 冲吸器接头  
Adaptor



Top Technology  
Top Products  
Top Service



尖端科技  
尖端产品  
尖端服务

[06]

## DQ-7型电切镜 (插口式) Resectoscopy set (Click)



A0012 30° 内窥镜  
Endoscope  
Φ4×302mm

1. 连接天松导光束  
连接OLYMPUS导光束  
连接STORZ导光束
2. 连接WOLF导光束
3. 连接ACMI STRYKER导光束

1. Connecting to TIANSONG light guide cable  
Connecting to OLYMPUS light guide cable  
Connecting to STORZ light guide cable
2. Connecting to WOLF light guide cable
3. Connecting to ACMI, STRYKER light guide cable

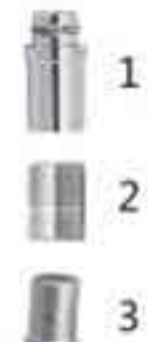

A3165.1 外鞘 Outer sheath 25.5Fr

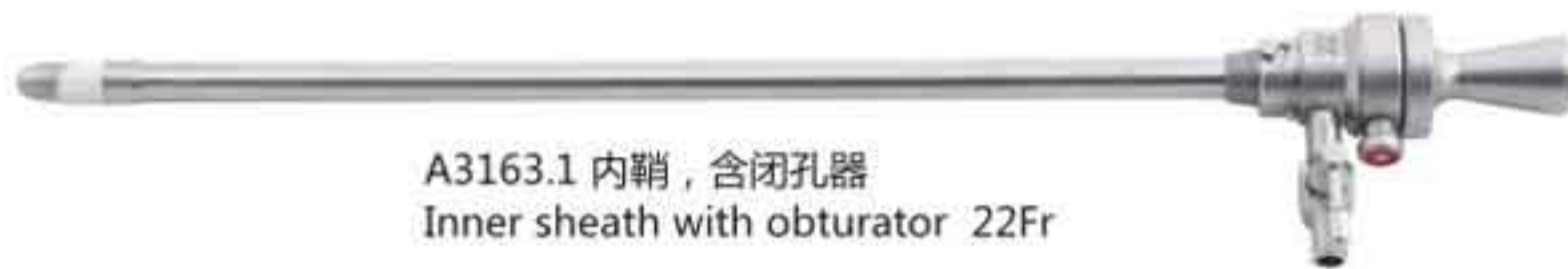

A3163.1 内鞘, 含闭孔器  
Inner sheath with obturator 22Fr



A3160.1 工作把手 (被动式)  
Working element (Passive)



手术电极 Electrode



A3111.1 环状  
Loop 30°



A3122 滚状  
Roller



A3123 齿状  
Spike



A3124.1 铲状  
Spud 30°



M1001 高频线 (单极)  
High frequency cord (Monopolar)



T4002 手动冲吸器 (艾利克式)  
Evacuator(Ellik)  
T1001.1 冲吸器接头  
Adaptor

DQ-8型电切镜 (插口式) Resectoscopy set (Click)

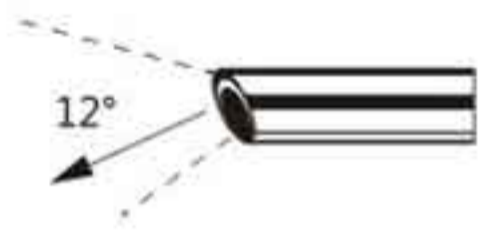

A0011 12° 内窥镜  
Endoscope  
Φ4×302mm

1. 连接天松导光束  
连接OLYMPUS导光束  
连接STORZ导光束
2. 连接WOLF导光束
3. 连接ACMI STRYKER导光束

1. Connecting to TIANSONG light guide cable  
Connecting to OLYMPUS light guide cable  
Connecting to STORZ light guide cable
2. Connecting to WOLF light guide cable
3. Connecting to ACMI, STRYKER light guide cable

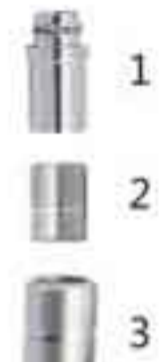

A3165.2 外鞘 Outer sheath 25.5Fr

A3163.2 内鞘, 含闭孔器  
Inner sheath with obturator 22Fr



A3162 工作把手 (被动式)  
Working element (Passive)



手术电极 Electrode



A3111 环状  
Loop



A3122 滚状  
Roller



A3123 齿状  
Spike



A3124 铲状  
Spud



M1001 高频线 (单极)  
High frequency cord (Monopolar)



T4002 手动冲吸器 (艾利克式)  
Evacuator(Ellik)  
T1001.5 冲吸器接头  
Adaptor



Top Technology  
Top Products  
Top Service



尖端科技  
尖端产品  
尖端服务

[08]

## DQ-10型电切镜 (插口/双极) Resectoscopy set (Click/Bipolar)

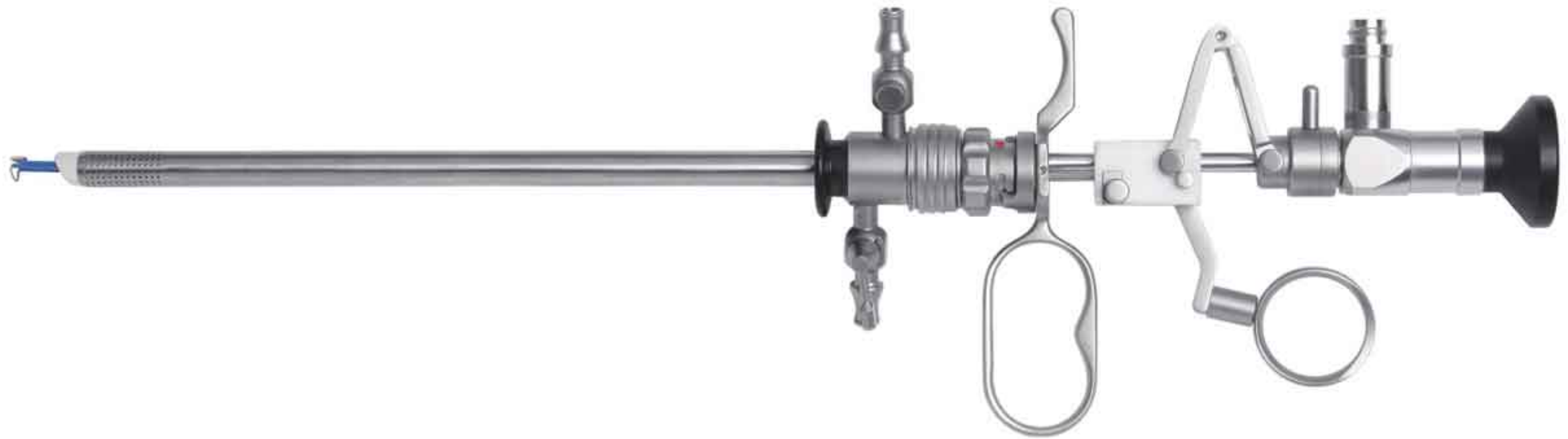

A0011.3 12° 内窥镜  
Endoscope  
Φ4×299.5mm

1. 连接天松导光束  
连接OLYMPUS导光束  
连接STORZ导光束
2. 连接WOLF导光束
3. 连接ACMI STRYKER导光束

1. Connecting to TIANSONG light guide cable  
Connecting to OLYMPUS light guide cable  
Connecting to STORZ light guide cable
2. Connecting to WOLF light guide cable
3. Connecting to ACMI, STRYKER light guide cable

- 1
- 2
- 3



A3160.4SS 工作把手 (被动式)  
Working element (Passive)



T4002 手动冲吸器 (爱利克式)  
Evacuator (Elik)  
T1001.6 冲吸器接头  
Adaptor



A3165.3SS 外鞘 Outer sheath 26.5Fr



A3163.3SS 内鞘, 含闭孔器 Inner sheath with obturator 24.5Fr



A3131 手术电极 Electrode  
环状, 双杆双极 Double shaft bipolar

DQ-9型小儿电切镜 (锁扣式) Pediatric Resectoscopy set (Lockable)



A0210 0° 内窥镜  
Endoscope  
Φ2.7×205mm



T4002 手动冲吸器 (爱利克式)  
Evacuator(Ellik)  
T1001.10 冲吸器接头  
Adaptor

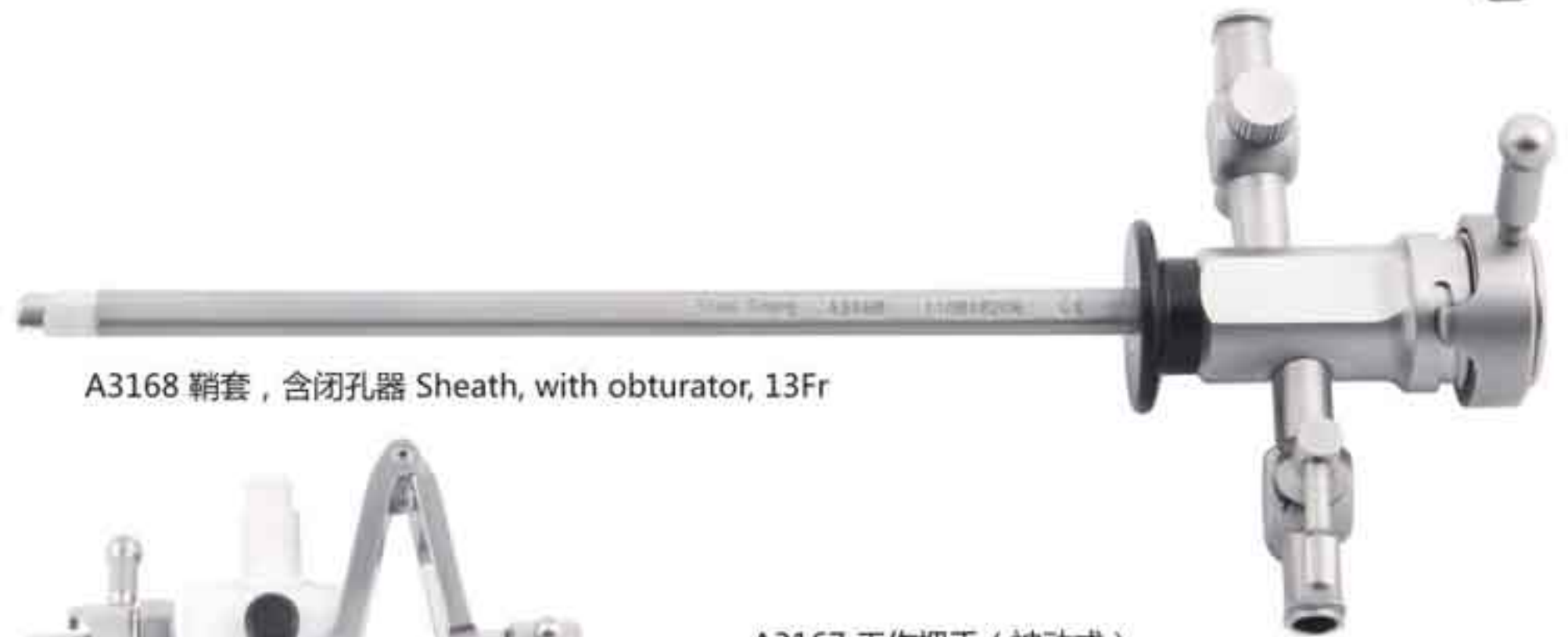

A3168 鞘套, 含闭孔器 Sheath, with obturator, 13Fr

A3167 工作把手 (被动式)  
Working element(Passive)



M1001 高频线 (单极)  
High frequency cord (Monopolar)



手术电极 Electrode  
A3111.2 环状 Loop

电切镜通用件 Resectoscope set interchangeable parts



M0015 高频发生器 (多功能型)  
H.F Generator(Multifunction)



T5010 导光束 Light guide cable  
Φ4.5×2000mm



T1009.1 进水阀门  
Luer-lock adaptor



T1001 连接器 Adaptor



Top Technology  
Top Products  
Top Service



尖端科技  
尖端产品  
尖端服务

[10]

## PS-3型膀胱碎石镜 (头弯式) Lithotripsy set (Curved head)



## PS-4型膀胱碎石镜 (直式) Lithotripsy set (Straight)



## PS-3/PS-4型膀胱碎石通用件 Lithotripsy interchangeable parts



T4002 手动冲吸器 (爱利克式)  
Evacuator(Ellik)  
T1001.2 冲吸器接头  
Adaptor



T4003 冲吸器 (霍夫曼式)  
Evacuator(Hoffman)



T5010 导光束  
Light guide cable  $\Phi 4.5 \times 2000\text{mm}$



T1009.1 进水阀门  
Luer-lock adaptor



T1001 连接器 Adaptor

SS-3型输尿管肾镜 Ureterorenoscopy set

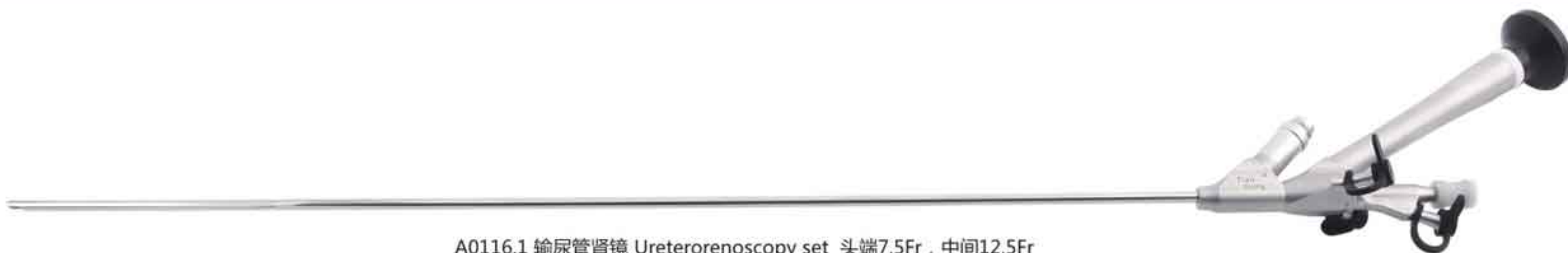

A0116.1 输尿管肾镜 Ureterorenoscopy set 头端7.5Fr, 中间12.5Fr



A2112.1 输尿管扩张器 Dilator 13 Fr  
A2112.2 输尿管扩张器 Dilator 11 Fr  
A2112.3 输尿管扩张器 Dilator 9 Fr



T1009.1 进水阀门  
Luer-lock adaptor



A2145 密封帽 sealing cap

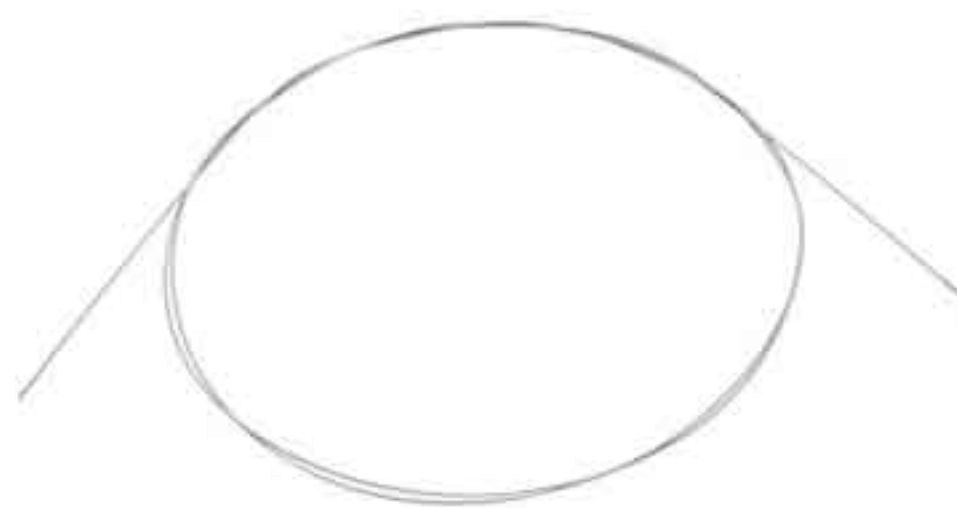

A2001 金属导丝  
Metal wire



T5010 导光束 Light guide cable  
Φ4.5×2000mm



A2108.2 抓钳, 硬性  
Grasping forceps, rigid  
4.5 Fr×600mm



A2109.2 活检钳, 硬性  
Biopsy forceps, rigid  
4.5 Fr×600mm



A2110.2 抓钳, 软性  
Grasping forceps, flexible  
4.5 Fr×600mm



A2111.2 活检钳, 软性  
Biopsy forceps, flexible  
4.5 Fr×600mm

输尿管肾镜选购件 Ureterorenoscopy set options

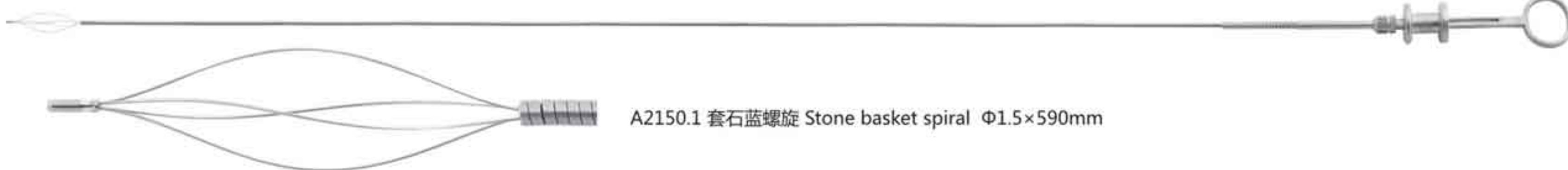

A2150.1 套石篮螺旋 Stone basket spiral Φ1.5×590mm



A2108 抓钳, 硬性 5Fr×600mm  
Grasping forceps, rigid  
A2108.3 抓钳, 硬性 4Fr×600mm  
Grasping forceps, rigid



A2109 活检钳, 硬性 5Fr×600mm  
Biopsy forceps, rigid  
A2109.3 活检钳, 硬性 4Fr×600mm  
Biopsy forceps, rigid



A2110 抓钳, 软性 5Fr×600mm  
Grasping forceps, flexible  
A2110.3 抓钳, 软性 4Fr×600mm  
Grasping forceps, flexible



A2111 活检钳, 软性 5Fr×600mm  
Biopsy forceps, flexible  
A2111.3 活检钳, 软性 4Fr×600mm  
Biopsy forceps, flexible



Top Technology  
Top Products  
Top Service



尖端科技  
尖端产品  
尖端服务

[12]

## JP-1型经皮肾镜 Percutaneous Nephroscope Set



A0118 经皮肾镜 Side-View endoscope 16Fr



A3170.1 鞘套 Sheath 19Fr



A3174 扩张器 Dilator 9-21Fr



A3171 穿刺器 Trocar 4.5Fr



A3175 开式引导器 Open conductor



A3173 扩张套管鞘套 Dilator cannula 6Fr, 7.5Fr, 9Fr

A3172 导杆 Guide Bar 9Fr



T1009.1 进水阀门  
Luer-lock adaptor



T1001 连接器 Adaptor



A2145 密封帽 Sealing cap

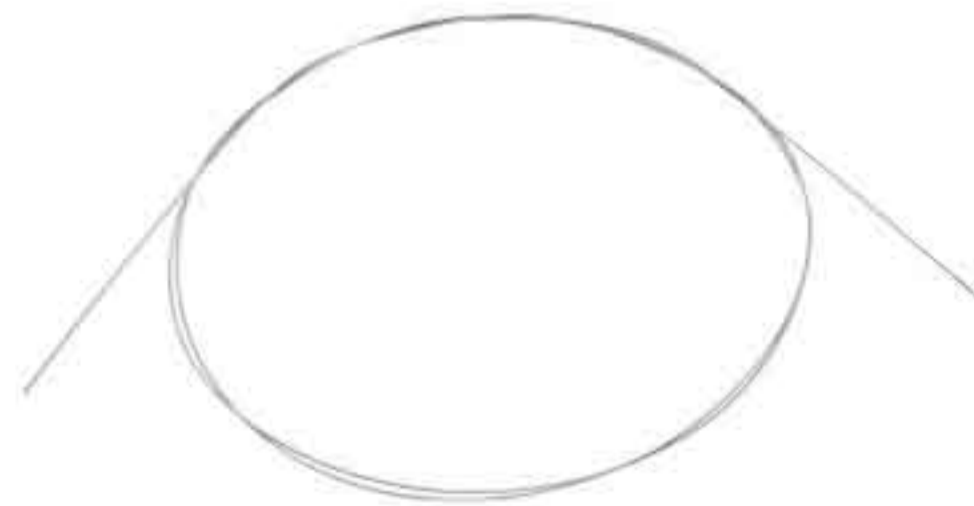

A2001 金属导丝  
Metal Wire



T5010 导光束 Light guide cable  
Φ4.5×2000mm



A2152 锯齿形抓钳  
Serrated forceps  
10.5 Fr×350mm



A2153 抓取钳  
Grasping forceps  
10.5 Fr×350mm



A2154 三爪抓钳  
Three claws, grasping forceps  
10.5 Fr×350mm



A2155 异物钳  
Foreign body forceps  
10.5 Fr×350mm





## 泌尿外科手术器选购件 Urology instruments options

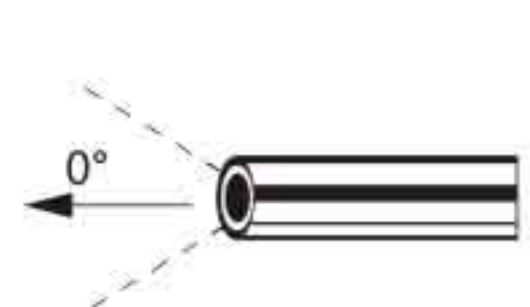

- A0010 0° Φ4×302mm
- A0020 0° Φ2.9×302mm
- A0210 0° Φ2.7×205mm 小儿 Pediatric
- A0220 0° Φ2.9×302mm
- 耐134°2bar高温高压 Autoclave
- A0320 0° Φ4×302mm 广角 Wide angle
- 耐134°2bar高温高压 Autoclave



A3160.3S 工作把手 锁扣主动式30° 配4型电切镜  
Working element, Active, for model 4 resectoscopy set



- A0011 12° Φ4×302mm
- A0041 12° Φ4×302mm 仿顺康ACMI



A3161 工作把手 锁扣主动式12° 配8型电切镜  
Working element, Active, for model 8 resectoscopy set



- A0012 30° Φ4×302mm
- A0022.1 30° Φ3×302mm
- A0022.2 30° Φ2.7×302mm
- A0211 30° Φ2.7×205mm 小儿 Pediatric
- A0042 30° Φ4×302mm 仿顺康ACMI
- A0222 30° Φ2.9×302mm
- 耐134°2bar高温高压 Autoclave
- A0322 30° Φ4×302mm 广角 Wide angle
- 耐134°2bar高温高压 Autoclave

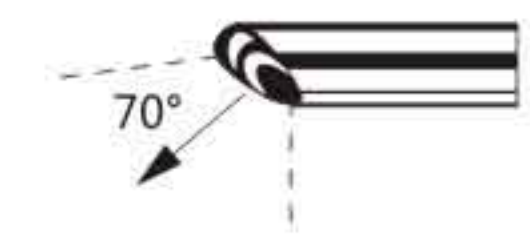

- A0013 70° Φ4×302mm
- A0023.1 70° Φ3×304mm
- A0323 70° Φ4×304mm 广角 Wide angle
- 耐134°2bar高温高压 Autoclave



光学钳 (锁口式) Optical forceps (Lockable)



A2100 光学咬切钳, 配0° 镜子  
Optical punch forceps,  
used with 0°endoscope



A2106 光学活检钳, 配30° 镜子  
Optical biopsy forceps,  
used with 30°endoscope



A2105 光学抓钳, 配0° 镜子  
Optical grasping forceps,  
used with 0°endoscope



A2107 剪刀状, 配0° 镜子  
Optical scissors,  
used with 0°endoscope



光学钳 (插口式) optical forceps (Click)



A2105.1 光学抓钳, 配0° 镜子  
Optical grasping forceps,  
used with 0°endoscope



A2106.1 光学活检钳, 配30° 镜子  
Optical biopsy forceps,  
used with 30°endoscope



A2107.1 剪刀状, 配0° 镜子  
Optical scissors,  
used with 0°endoscope

泌尿外科手术器选购件 ( 续 ) Urology instruments options



尿道扩张器, 男性 Male urethral dilator 8Fr-30Fr

- |              |               |               |
|--------------|---------------|---------------|
| A2113 8Fr    | A2113.8 16Fr  | A2113.16 24Fr |
| A2113.1 9Fr  | A2113.9 17Fr  | A2113.17 25Fr |
| A2113.2 10Fr | A2113.10 18Fr | A2113.18 26Fr |
| A2113.3 11Fr | A2113.11 19Fr | A2113.19 27Fr |
| A2113.4 12Fr | A2113.12 20Fr | A2113.20 28Fr |
| A2113.5 13Fr | A2113.13 21Fr | A2113.21 29Fr |
| A2113.6 14Fr | A2113.14 22Fr | A2113.22 30Fr |
| A2113.7 15Fr | A2113.15 23Fr |               |



A2130 阴茎夹 Penis clamps



尿道扩张器, 女性 Female urethral dilator 18Fr-42Fr

- |              |              |              |
|--------------|--------------|--------------|
| A2114.1 18Fr | A2114.4 27Fr | A2114.7 36Fr |
| A2114.2 21Fr | A2114.5 30Fr | A2114.8 39Fr |
| A2114.3 24Fr | A2114.6 33Fr | A2114.9 42Fr |



A2116.1 Φ18-38mm 尿道扩张器(可调式带刀)  
Urethral filar sound dilator (with knife)



膀胱穿刺针 Bladder trocar  
A2131.1a 1×5 20Fr  
A2131.1b 1×5 16Fr  
A2131.1c 1×5 18Fr  
A2131.1d 1×5 22Fr



A2148 敷料钳直 Dressing forceps straight 200mm  
A2149 敷料钳弯 Dressing forceps curved 200mm



造接针 Fistula needle  
A2131.2 20Fr  
A2131.3 18Fr  
A2131.4 22Fr  
A2131.5 16Fr  
A2131.6 24Fr



A2101.1 活检钳, 硬性  
Biopsy forceps, rigid  
7Fr×395mm

A2102.1 异物钳, 硬性  
Foreign body forceps, rigid  
7Fr×395mm

A2103.1 抓钳, 锯齿状, 硬性  
Serrated forceps, rigid  
7Fr×395mm



T1001.1 冲吸器接头配6、7型电切镜  
Adaptor for model 6、7 resectoscopy set  
T1001.5 冲吸器接头配8型电切镜  
Adaptor for model 8 resectoscopy set

T1001.2 冲吸器接头  
配大力碎石钳  
Adaptor for lithotrite

T1001.3 连接器接头  
配气腹针接头  
Adaptor for veress needle

T1001.4 冲吸器接头  
配WOLF膀胱镜  
Adaptor for WOLF cystoscope

T1001.6 冲吸器接头  
配STORZ电切镜  
Adaptor for STORZ  
resectoscopy set

T1009.2 连接器  
Adaptor

手术电极, 双杆单极 Electrode, double shaft monopolar



A3127 直环 straight loop



A3129 滚状 roller



A3130 铲状 spud



A3128 环状 loop



Top Technology  
Top Products  
Top Service



尖端科技  
尖端产品  
尖端服务

[14]

## 手术电极 Electrode

配TIANSONG

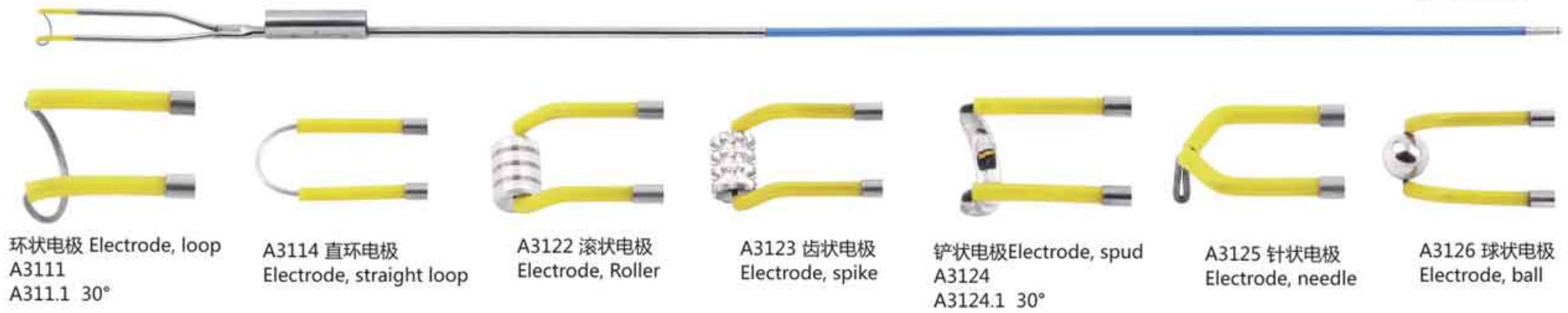

环状电极 Electrode, loop  
A3111  
A311.1 30°

A3114 直环电极  
Electrode, straight loop

A3122 滚状电极  
Electrode, Roller

A3123 齿状电极  
Electrode, spike

铲状电极 Electrode, spud  
A3124  
A3124.1 30°

A3125 针状电极  
Electrode, needle

A3126 球状电极  
Electrode, ball

配STORZ



1-DS-24 直环电极  
Electrode, straight loop

1.2-DS-24 环状电极 loop 90°  
1.3-DS-24 环状电极 loop 30°

2-DS-24 针状电极  
Electrode, needle

3.1-DS-24 铲状电极  
Electrode, spud

4-DS-24 滚状电极  
Electrode, Roller

5-DS-24 齿状电极  
Electrode, spike

6-DS-24 球状电极  
Electrode, ball

配OLYMPUS



1-DO-24 直环电极  
Electrode, straight loop

环状电极 Electrode, loop  
1.2-DO-24  
1.3-DO-24 30°

2-DO-24 针状电极  
Electrode, needle

3-DO-24 铲状电极  
Electrode, spud

4-DO-24 滚状电极  
Electrode, Roller

5-DO-24 齿状电极  
Electrode, spike

6-DO-24 球状电极  
Electrode, ball

配WOLF



1-DW-24 环状电极  
Electrode, loop

环状电极 Electrode, loop  
1.2-DW-24  
1.3-DW-24 30°

2-DW-24 针状电极  
Electrode, needle

3-DW-24 铲状电极  
Electrode, spud

4-DW-24 滚状电极  
Electrode, Roller

5-DW-24 齿状电极  
Electrode, spike

6-DW-24 球状电极  
Electrode, ball

配CIRCOU

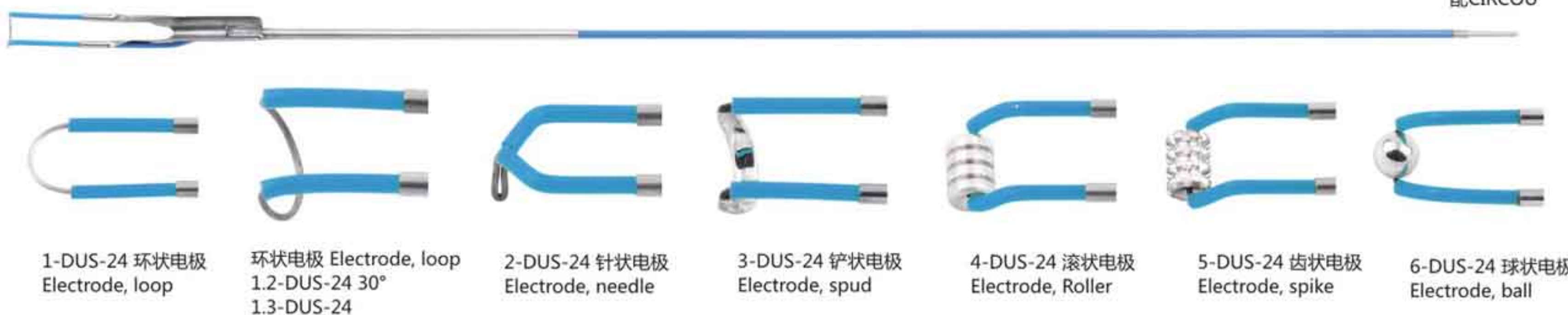

1-DUS-24 环状电极  
Electrode, loop

环状电极 Electrode, loop  
1.2-DUS-24 30°  
1.3-DUS-24

2-DUS-24 针状电极  
Electrode, needle

3-DUS-24 铲状电极  
Electrode, spud

4-DUS-24 滚状电极  
Electrode, Roller

5-DUS-24 齿状电极  
Electrode, spike

6-DUS-24 球状电极  
Electrode, ball

腹腔镜手术器械 Laparoscopy instruments

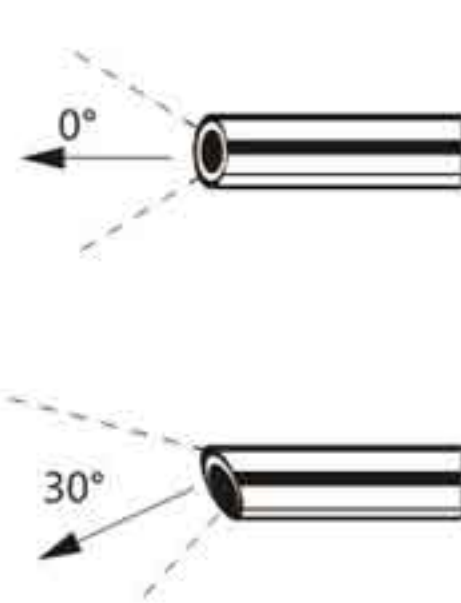

- E0001.1 0° Φ10×330mm
- E0004.1 0° Φ5×302mm  
耐134° C2bar高温高压 Autoclave
- E0007 0° Φ10×330mm 广角 Wide angle
- E0021 0° Φ10×330mm  
耐134° C2bar高温高压 Autoclave
- E0002.1 30° Φ10×330mm
- E0005.1 30° Φ5×302mm  
耐134° C2bar高温高压 Autoclave
- E0008 30° Φ10×330mm 广角 Wide angle
- E0022 30° Φ10×330mm  
耐134° C2bar高温高压 Autoclave

1. 连接天松导光束  
Connecting to TIANSONG light guide cable  
连接OLYMPUS导光束  
Connecting to OLYMPUS light guide cable  
连接STORZ导光束  
Connecting to STORZ light guide cable
2. 连接WOLF导光束  
Connecting to WOLF light guide cable
3. 连接ACMI STRYKER导光束  
Connecting to ACMI, STRYKER light guide cable



E2001.1 单动Single action  
E2001.5 可拆卸 单动  
Detachable, single action



E2001.2 双动 Double action



E2001.3 直角 Right angle



E2001.7 配强生钛钳夹  
For Johnson clip



E2001.8 配塑料夹  
For Plastic clip  
E2001.11 Φ10×330mm



E2001.9 配强生塑料夹  
For Johnson plastic clip



E2001.10 配威克钛夹  
For weck clip

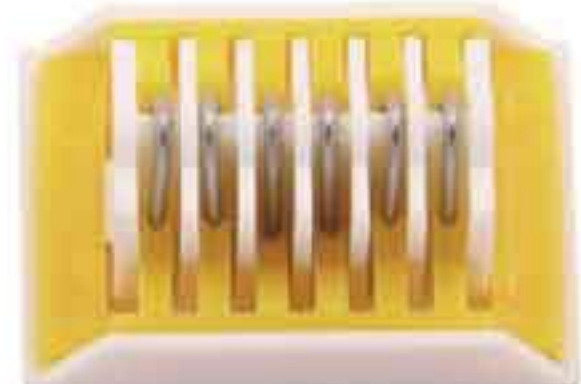

E5001 钛夹 4#Clip



E5001.1 钛夹2#Clip



E5002 钛夹3#Clip



E5003 钛夹 5#clip

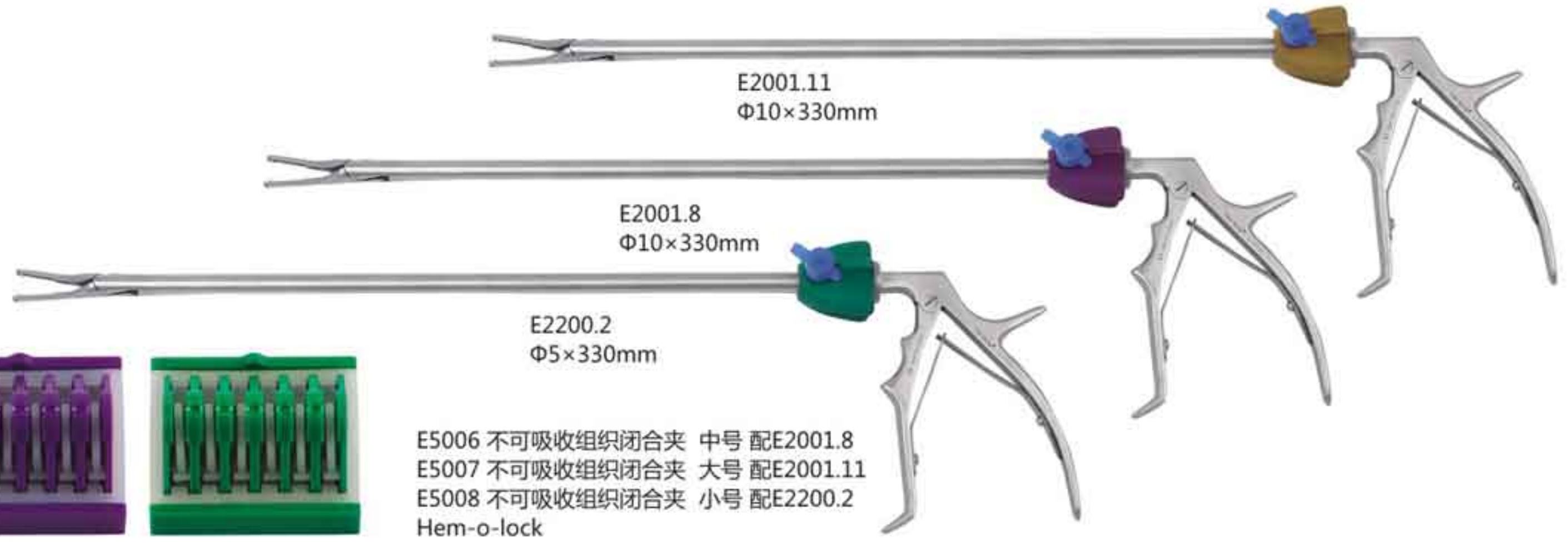

大号



中号



小号



Top Technology  
Top Products  
Top Service



尖端科技  
尖端产品  
尖端服务

[16]

## 腹腔镜手术器械 Laparoscopy instruments



E5010 可吸收组织闭合夹 12mm  
E5011 可吸收组织闭合夹 8mm  
Absorbable clip



E2001.6 钛钳夹  
Biological clip applicator  
Φ10×330mm



## 可拆卸手术器械 Detachable operating forceps

### E2系列钳子拆卸图 E2 version assembly

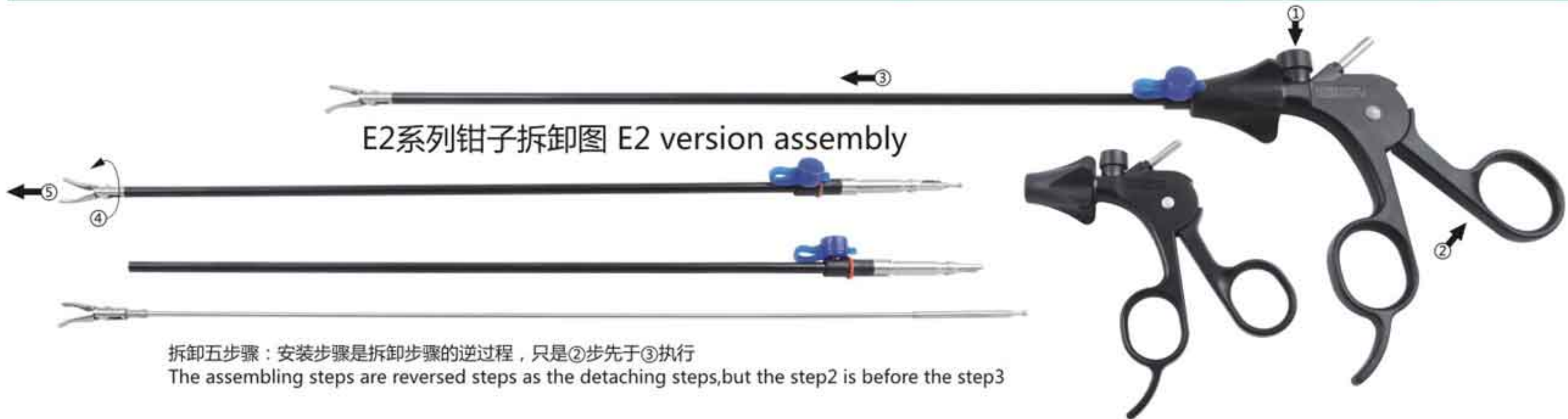

拆卸五步骤：安装步骤是拆卸步骤的逆过程，只是②步先于③执行  
The assembling steps are reversed steps as the detaching steps, but the step2 is before the step3

### E9系列钳子拆卸图 E9 version assembly



拆卸四步骤：安装步骤是拆卸步骤的逆过程  
The assembling steps are reversed steps as the detaching steps

## 可弯曲可旋转手术器械 Flexible and rotatable forceps



旋转弯曲示意图 Schematic diagram



E2005.1KW 分离钳，直  
Dissecting forceps, straight



E2005.2KW 分离钳，弯  
Dissecting forceps, curved



E2005.8KW 抓钳，锯齿型  
Fixation grasping forceps, serrated



E2005.9KW 抓钳，环型  
Fixation grasping forceps, loop



E2006.1KW 剪刀，直  
Scissor, straight



E2006.3KW 剪刀，弯（头长15mm）  
Scissor, curved



E2007.9KW 抓钳（头长21mm）  
Gallbladder grasping forceps



E2007.10KW 抓钳，细齿中空（头长21mm）  
Grasping forceps, greeve tooth

腹腔镜手术器械 Φ5×330mm Laparoscopy instruments

PPSU手柄 Handle①  
(134°C 2bar)



PPSU 手柄 Handle  
(134°C 2bar)  
耐高温高压 Autoclave



- 手柄耐高温高压 Autoclave
- 产品编号以E9开头, 如E2005.1变为E9005.1  
The code number for PPSU handle series is beginning with E9  
Eg: E2005.1 E9005.1



E2005.1 分离钳, 直(头长17mm)  
Dissecting forceps, straight  
(Head length 17mm)



E2005.7 抓钳, 鳄鱼口型(头长17mm)  
Fixation grasping forceps, crocodile  
(Head length 17mm)



E2006.3 剪刀, 弯(头长15mm)  
Scissor, curved  
(Head length 15mm)



E2007.5 抓钳, 无损伤(头长15mm)  
Atraumatic grasping forceps  
(Head length 15mm)



E2005.2 分离钳, 弯(头长17mm)  
Dissecting forceps, curved  
(Head length 17mm)  
头长可做12/14/18/20/25mm  
E2005.2C 头长18mm  
E2005.2D 头长20mm



E2005.8 抓钳, 锯齿型(头长13mm)  
Fixation grasping forceps, serrated  
(Head length 13mm)



E2006.4 剪刀, 钩型, 单动(头长9mm)  
Scissor, hook, Single action  
(Head length 9mm)



E2007.6 抓钳, 双齿, 单动(头长15mm)  
Grasping forceps, rat toothed  
Single action  
(Head length 15mm)



E2005.3 分离钳 30°(头长17mm)  
Dissecting forceps, 30°angled  
(Head length 17mm)



E2005.9 抓钳, 环型(头长17mm)  
Fixation grasping forceps, loop  
(Head length 17mm)



E2006.10 剪刀, 弯, 带圆头(头长16mm)  
Scissor, curved, head with ball  
(Head length 16mm)



E2007.7 抓钳, 碗形(头长10mm)  
Grasping forceps, double spoon  
(Head length 10mm)



E2005.4 分离钳 45°(头长17mm)  
Dissecting forceps, 45°angled  
(Head length 17mm)



E2005.15 抓钳  
Grasping forceps



E2007 抓钳(头长14mm)  
Grasping forceps  
(Head length 14mm)



E2007.8 抓钳, 粗齿胆囊(头长18mm)  
Gallbladder grasping forceps rough  
toothed(Head length 18mm)



E2005.5 分离钳70°(头长17mm)  
Dissecting forceps, 70°angled  
(Head length 17mm)



E2006.1 剪刀, 直(头长13mm)  
Scissor, straight  
(Head length 13mm)



E2007.1 抓钳(头长17mm)  
Blunt grasping forceps  
(Head length 17mm)



E2007.9 抓钳, 胆囊(头长21mm)  
Gallbladder grasping forceps  
toothed(Head length 21mm)



E2005.6 分离钳90°(头长17mm)  
Dissecting forceps, 90°angled  
(Head length 17mm)  
E2035 头长13mm (Head length 13mm)



E2006.2 剪刀, 直, 单动(头长13mm)  
Scissor, straight, Single action  
(Head length 13mm)



E2007.4 抓钳, 无损伤, 单动(头长18mm)  
Atraumatic grasping forceps Single action  
(Head length 18mm)



E2007.10 抓钳, 细齿中空(头长21mm)  
Grasping forceps, greeve tooth  
(Head length 21mm)



Top Technology  
Top Products  
Top Service



尖端科技  
尖端产品  
尖端服务

[18]

## 腹腔镜手术器械 $\Phi 5 \times 330\text{mm}$ Laparoscopy instruments



E2007.11 抓钳(头长21mm)  
Grasping forceps  
(Head length 21mm)



E2007.20 抓钳, 单动(头长15mm)  
Grasping forceps Single action  
(Head length 15mm)



E2007.31 抓钳, 头顶部圆形碗(头长22mm)  
Grasping forceps, round spoon head  
(Head length 22mm)



E2007.39 抓钳, 粗齿中空(头长21mm)  
Grasping forceps, tough tooth, hollow  
(Head length 21mm)



E2007.12 抓钳, 单动(头长32mm)  
Grasping forceps Single action  
(Head length 32mm)



E2007.21 抓钳(头长22mm)  
Grasping forceps  
(Head length 22mm)



E2007.32 抓钳, 单齿(头长21mm)  
Single tooth grasping forceps  
(Head length 21mm)



E2007.41 抓钳  
Grasping forceps



E2007.13 抓钳, 长颈形(头长25mm)  
Grasping forceps, flask style  
(Head length 25mm)



E2007.22 抓钳, 阑尾(头长21mm)  
Appendix grasping forceps  
(Head length 21mm)



E2007.33 抓钳  
Grasping forceps



E2007.42 抓钳, 输尿管  
Grasping forceps



E2007.14 抓钳, 抱合式(头长30mm)  
Grasping forceps, clasp  
(Head length 30mm)



E2007.23 抓钳, 无损伤(头长30mm)  
Atraumatic grasping forceps  
(Head length 30 mm)



E2007.34 抓钳  
Grasping forceps



E2018A6 肺叶钳(头长32mm)  
Lung forceps  
(Head length 32mm)



E2007.16 抓钳, 2×3齿单动(头长30mm)  
Grasping forceps 2×3 teeth, Single action  
(Head length 30mm)



E2007.24 抓钳, 带钝钉头(头长14mm)  
Grasping forceps, blunt-pointed  
With nail(Head length 14mm)



E2007.34A 胃抓钳  
Stomach grasping forceps



E2007.43 抓钳  
Grasping forceps



E2007.17 抓钳, 3×4单动(头长30mm)  
Grasping forceps 3×4 teeth, Single action  
(Head length 30mm)



E2007.25 抓钳, 重型(头长18mm)  
Grasping forceps, heavy type  
(Head length 18mm)



E2007.35 抓钳, 吻合牵引  
Anastomosis traction forceps



E2007.44 抓钳  
Grasping forceps



E2007.18 抓钳, 无损伤 Allie式(头长30mm)  
Atraumatic grasping forceps, Allie  
(Head length 30mm)



E2007.26 抓钳, 双齿2×3(头长18mm)  
Grasping forceps 2×3teeth  
(Head length 18mm)



E2007.35C 抓钳, 吻合牵引  
Anastomosis traction forceps



E2007.45 抓钳, 网纹  
Grasping forceps, reticulate



E2007.19 抓钳, 派克式(头长13mm)  
Grasping forceps, Parker  
(Head length 13mm)



E2007.27 抓钳  
Grasping forceps



E2007.36 抓钳(头长19mm)  
Grasping forceps  
(Head length 19mm)



E2007.46 抓钳, 鸭嘴  
Grasping forceps

腹腔镜手术器械 Φ5×330mm Laparoscopy instruments



E2007.47 抓钳  
Grasping forceps



E2020 打结钳, A型(头长17mm)  
Tieing forceps, type A  
(Head length 17mm)



E2022C 肠钳  
Intestinal forceps



E2025 抓钳, 鳄鱼头(头长15mm)  
Grasping forceps, crocodile head  
(Head length 15mm)



E2007.48 抓钳  
Grasping forceps



E2020.1 打结钳, B型(头长17mm)  
Tieing forceps, type B  
(Head length 17mm)



E2022D 肠钳  
Intestinal forceps



E2034 抓钳, 蛇形(头长15mm)  
Grasping forceps, snake  
(Head length 15mm)



E2007.49 输卵管抓钳  
Salpinx Grasping forceps



E2021 单动(头长15mm)  
Small biopsy forceps, single action  
(Head length 15mm)



E2024 抓钳, 子弹头(头长15mm)  
Grasping forceps, bullet head  
(Head length 15mm)



E2007.91 抓钳, 小抱合口  
Gallbladder grasping forceps



E2022 肠钳(头长40mm)  
Intestinal forceps  
(Head length 40mm)



E2024.1 抓钳, 子弹头带碗(头长12mm)  
Grasping forceps, round bullet head  
with spoon (Head length 12mm)

滑道式腹腔镜手术器械 Φ5×330mm Slide laparoscopy instruments



E2005.2 分离钳, 弯  
Dissecting forceps, curved



E2006.3 剪刀, 弯  
Scissor, curved



E2007.10 抓钳, 细齿中空  
Grasping forceps, greeve tooth

滑道式手术器械可以减少器械对组织的损伤, 产品编号以E2开头  
It can reduce the harm for tissue code number begins with E2

大型腹腔镜手术器械 Φ10×330mm Large laparoscopy instruments



E2002 抓钳, 单动(头长27mm)  
Large grasping forceps, Single action  
(Head length 27mm)



E2004 分离钳, 绝缘(头长22mm)  
Large dissecting forceps, insulated  
(Head length 22mm)



E2004.2 分离钳, 绝缘(头长22mm)  
Large dissecting forceps, insulated  
(Head length 22mm)



E2004.4 分离钳(头长30mm)  
Large dissecting forceps  
(Head length 30mm)



E2003 取石钳, 单动(头长30mm)  
Lithotomy forceps, Single action  
(Head length 30mm)



E2004.1 分离钳, 绝缘(头长22mm)  
Large dissecting forceps, insulated  
(Head length 22mm)



E2004.2A 分离钳, 90°绝缘(头长30mm)  
Large dissecting forceps, insulated  
(90°, Head length 30mm)



E2004.5 抓钳(头长60mm)  
Grasping forceps(Head length 60mm)



Top Technology  
Top Products  
Top Service



尖端科技  
尖端产品  
尖端服务

[20]

## 大型腹腔镜手术器械 $\Phi 10 \times 330\text{mm}$ Large laparoscopy instruments



E2004.6 分离钳 (头长23mm)  
Large dissecting forceps  
(Head length 23mm)



分离钳, 弯  
Large dissecting forceps  
E2005.410  
E2005.410A 45°



E2007.34C 抓钳  
Stomach Grasping forceps



E2008.65 抓钳, 哈巴狗  
Grasping forceps, Bulldog



E2004.7 抓钳, 鸭嘴形 (头长30mm)  
Grasping forceps, duck mouth  
(Head length 30mm)



E2006 剪刀, 直, 单动 (头长18mm)  
Large straight Scissor  
(Head length 18mm)



E2007.34D 抓钳  
Stomach Grasping forceps



E2008.66止血夹(长45mm/65mm)  
Hemostatic clips



E2004.8 抓钳, 无损伤 (头长36mm)  
Grasping forceps, atraumatic  
Head length 36mm



E2006.6 剪刀, 弯, 刀锋带齿单动(头长24mm)  
Large curved scissors  
blade with teeth, single action  
(Head length 24mm)



E2007.37 抓钳, 单齿  
Grasping forceps, single tooth



E2018 肺叶钳 (头长43mm)  
Lung forceps  
(Head length 43mm)



E2004.9 分离钳 (头长40mm)  
Large dissecting forceps  
(Head length 40mm)



E2006.8 剪刀, 弯(头长28mm)  
Large curved scissors  
(Head length 28mm)



抓钳 Grasping forceps  
E2007.52 E2007.53  
E2007.54



E2022.1 肠钳 (头长68mm)  
Intestinal forceps(Head length 68mm)



E2004.11 抓钳, 无损伤 (头长30mm)  
Grasping forceps, atraumatic  
Head length 30mm



E2006.11 剪刀, 直, 双动  
Large straight scissors



E2007.9C 抓钳, 抱合胆囊 (头长35mm)  
Gallbladder grasping forceps  
toothed(Head length 35mm)



E2004.12 分离钳, 90°  
Large dissecting forceps



E2004.14 取石钳, 双动  
Lithotomy forceps, double action



绝缘有齿抓钳 ( 双极 ) Bipolar coagulating forceps

配M1020高频线



绝缘组织分离钳，双极双动  
Insulated rotating dissecting forceps  
with tooth (bipolar, double action )  
E2312 Φ5×330mm  
E2312M Φ5×450mm

绝缘有齿抓钳  
Insulated rotating Grasping forceps with tooth  
双极双动，头长15mmBipolar double action ,  
Head length 15mm  
E2312.1 Φ5×330mm  
E2312.1M Φ5×450mm

绝缘有齿抓钳  
Insulated Grasping forceps with tooth  
双极双动，细齿中空  
Bipolar double action, greeve tooth mid-hole  
E2312.2 Φ5×330mm  
E2312.2M Φ5×450mm

配M1006高频线



绝缘有齿抓钳 ( 双极 )  
Insulated grasping forceps with tooth (bipolar)  
E2316 Φ5×330mm  
E2316.1 Φ 5×450mm

持针钳 Φ5×330mm(头长12mm) Needle holder(Head length 12mm)

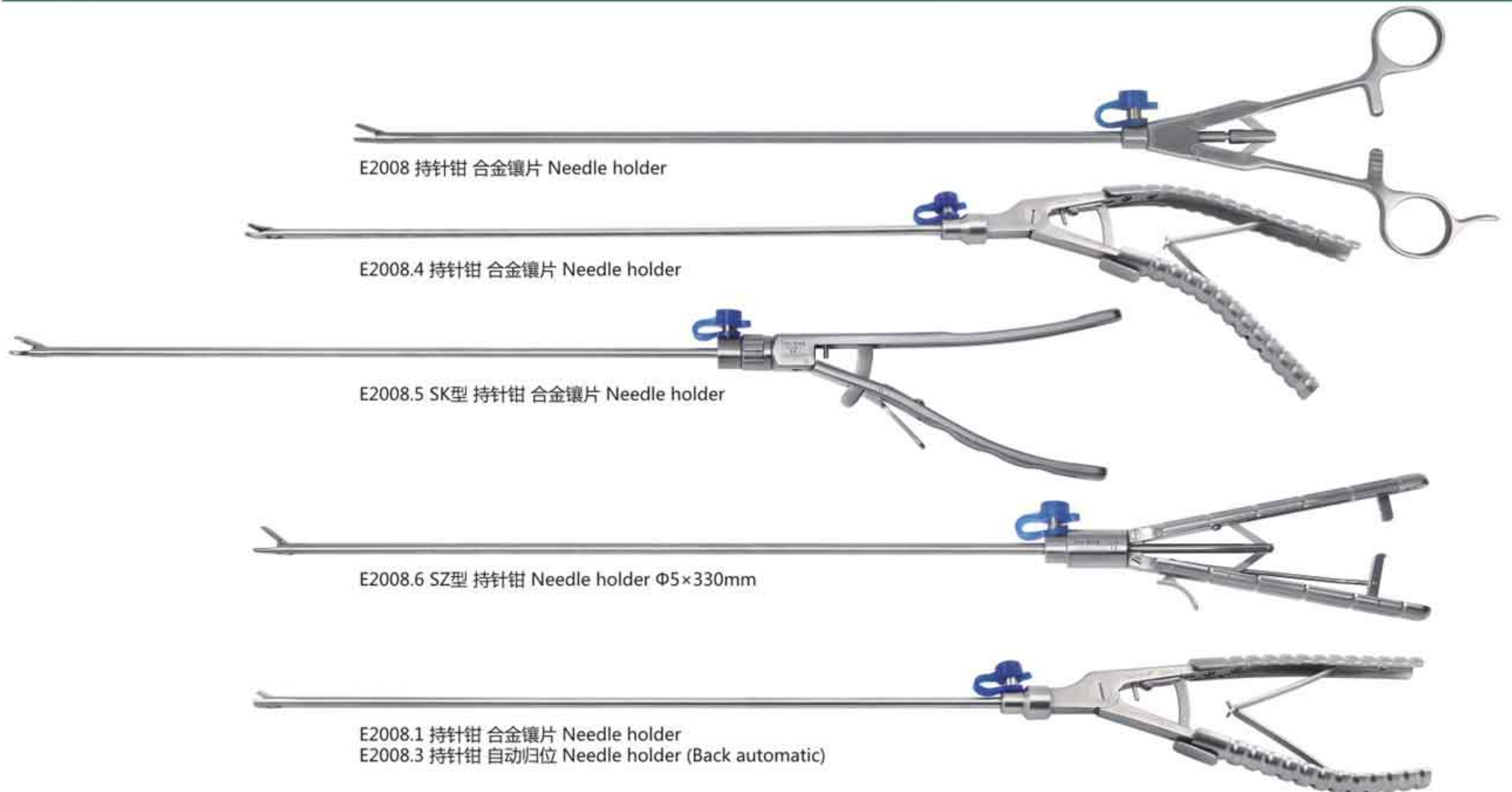

E2008 持针钳 合金镶片 Needle holder

E2008.4 持针钳 合金镶片 Needle holder

E2008.5 SK型 持针钳 合金镶片 Needle holder

E2008.6 SZ型 持针钳 Needle holder Φ5×330mm

E2008.1 持针钳 合金镶片 Needle holder  
E2008.3 持针钳 自动归位 Needle holder (Back automatic)



直头 Straight

左弯 Left curved

右弯 Right curved

自动归位 Back automatic



Top Technology  
Top Products  
Top Service



尖端科技  
尖端产品  
尖端服务

[22]

## 腹腔镜手术器械 $\Phi 3 \times 330/250/220\text{mm}$ Laparoscopy instruments



## 腹腔镜手术器械 Laparoscopy instruments

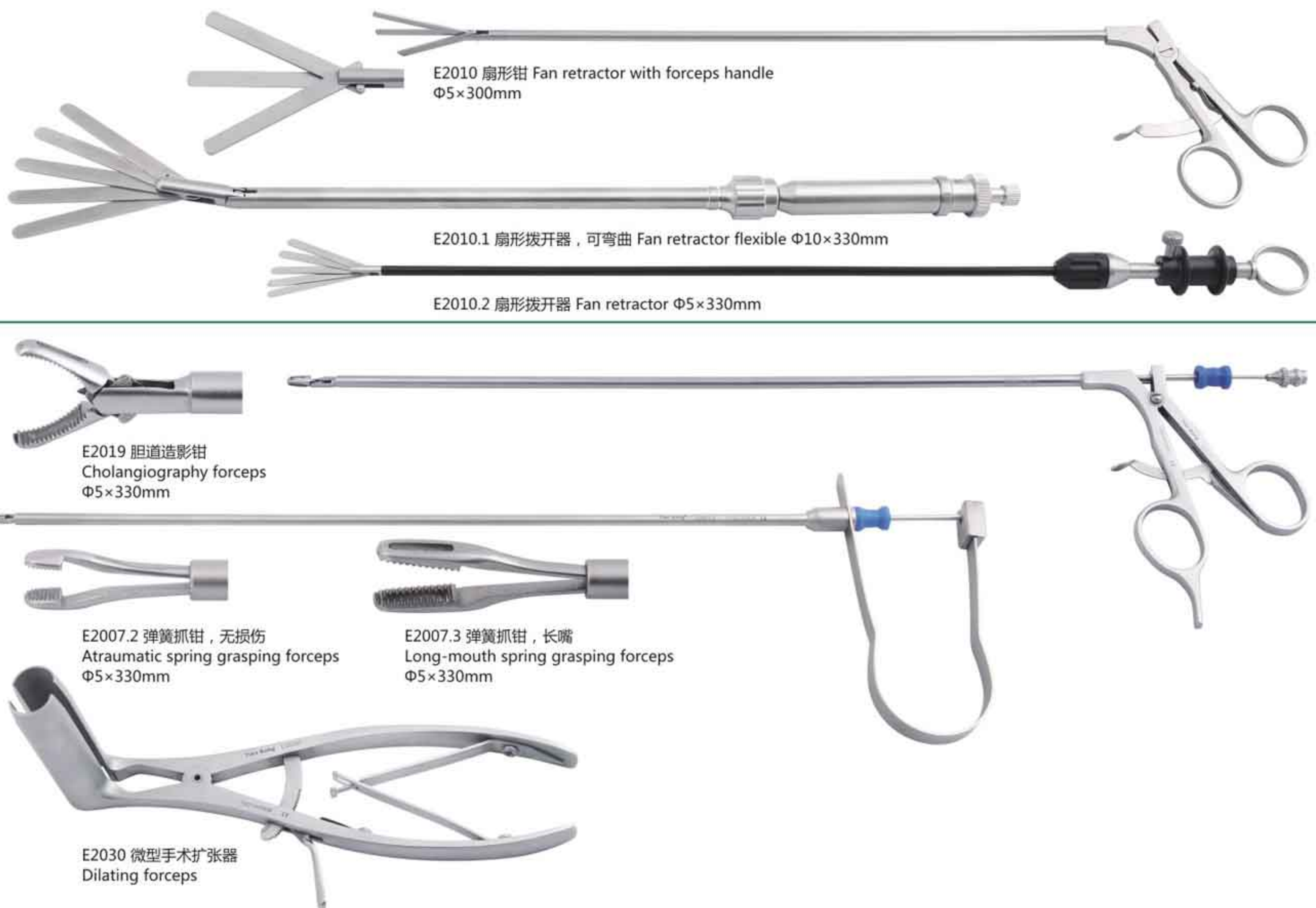

腹腔镜手术器械 Laparoscopy instruments

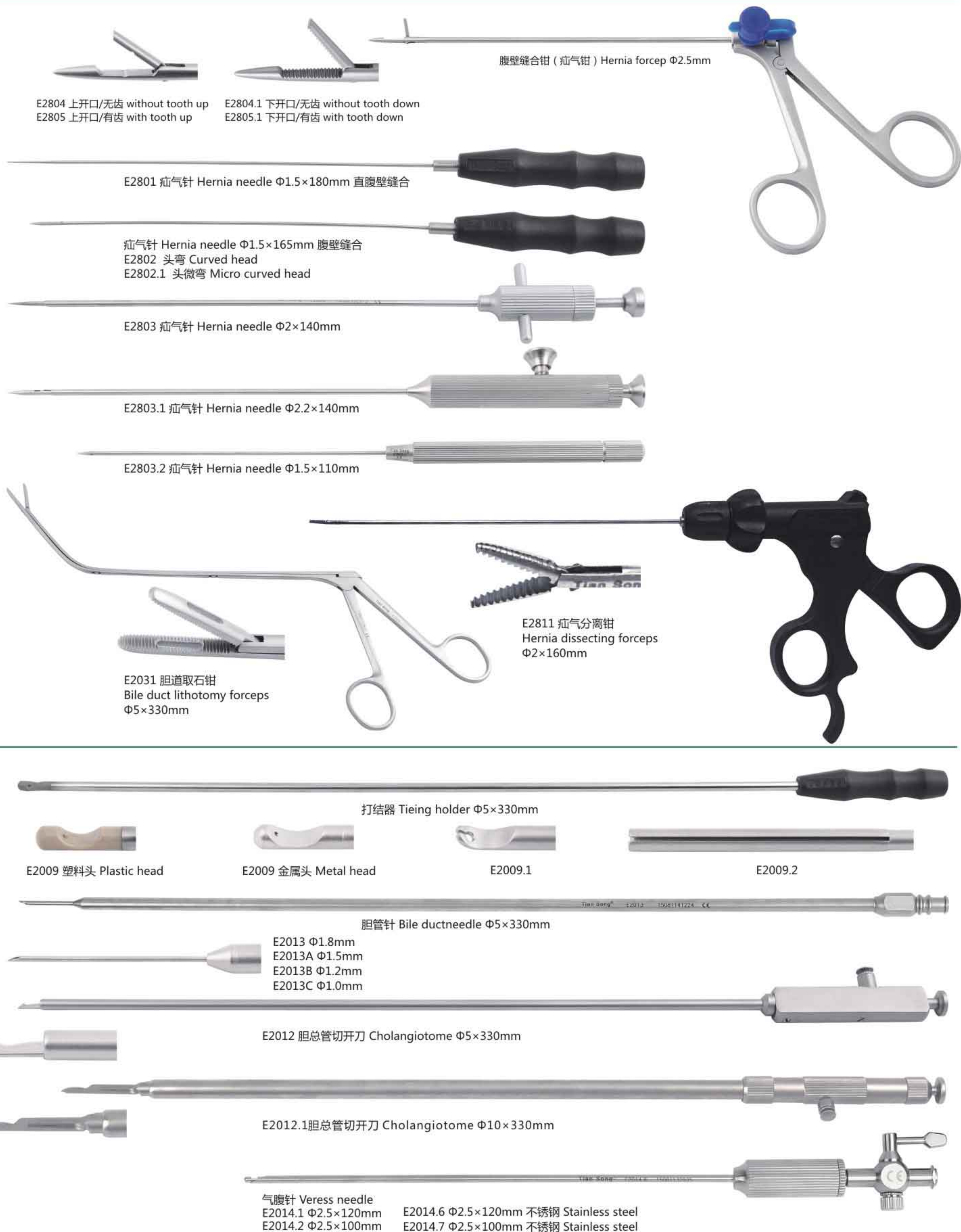



Top Technology  
Top Products  
Top Service



尖端科技  
尖端产品  
尖端服务

[24]

## 电凝器械 Electric coagulation instruments $\Phi 5 \times 330\text{mm}$



## 三通充水器 Suction and irrigation tube



穿刺器 Trocar set



带保护 With protection  
E2016.3 Φ10.5mm  
E2016.4 Φ5.5mm  
E2016.7 Φ11mm



带保护螺旋式 Spiral with protection  
E2016.3A Φ10.5mm  
E2016.4A Φ5.5mm



圆筒式 Cylindric  
E2016.5 Φ10.5mm    E2016.6 Φ5.5mm  
E2016.8 Φ11mm    E2016.9 Φ12mm  
E2016.10 Φ6mm



圆筒螺旋式 Cylindric, spiral  
E2016.5A Φ10.5mm  
E2016.6A Φ5.5mm



翻盖式 Multifunctional valve  
E2016.64 Φ5.5mm  
E2016.65 Φ10.5mm  
E2016.66 Φ11mm



翻盖式(不锈钢)  
Multifunctional valve(stainless steel)  
E2016.70 Φ11mm



转换器(不锈钢)Reducer(stainless steel)  
E2017.1 10mm/5mm  
E2017.2 5mm/3mm



E6001 密封帽    E6002 密封帽  
Sealing cap 5mm    Sealing cap 10mm



E2017.8 转换器(10/5活动式)  
Reducer(10/5 mobile type)



磁片式 Magnel  
E2016.12 Φ5.5mm  
E2016.13 Φ10.5mm  
E2016.14 Φ11mm  
E2016.15 Φ6mm  
E2016.16 Φ12mm  
E2016.19 Φ5.5mm 配 Stryker

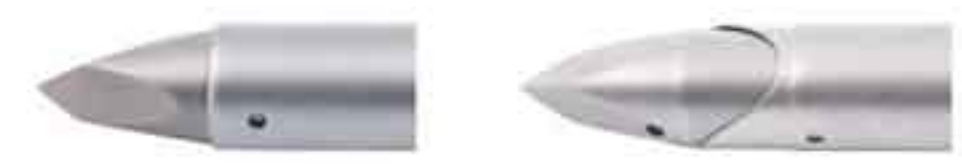

磁片螺旋式 Spiral magnet  
E2016.17 Φ5.5mm  
E2016.18 Φ10.5mm  
E2016.24 Φ6mm



磁片式带保护 Magnel, with protection  
E2016.20 Φ5.5mm  
E2016.21 Φ6mm  
E2016.22 Φ10.5mm  
E2016.23 Φ11mm



球阀式 Ball valve  
E2016.41 Φ5.5mm  
E2016.42 Φ6mm  
E2016.43 Φ10.5mm  
E2016.44 Φ11mm

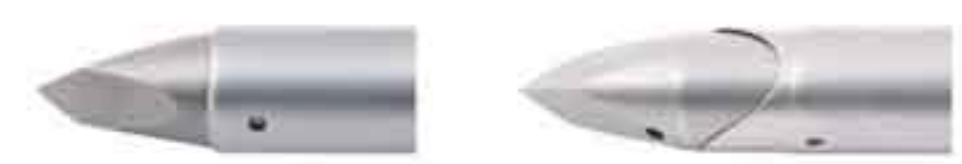

简易十字密封帽式  
Simple crossed sealing cap  
E2016.67 Φ6mm  
E2016.68 Φ10.5mm



E2017.4 转换器(工程塑料) Reducer  
(Engineering plastic)10mm/5mm



E2017.5 转换器(工程塑料扣状) Reducer  
(Engineering plastic button)10mm/5mm



Top Technology  
Top Products  
Top Service



尖端科技  
尖端产品  
尖端服务

26

## 甲状腺手术器械 Thyroid instruments



E2806 皮下剥离器 Subcutaneous dissector  $\Phi 10 \times 360\text{mm}$

E2807 可弯剥离器 Dissector, flexible  $\Phi 5 \times 350\text{mm}$

E2808 甲状腺分离器 Thyroid dissector  $\Phi 5 \times 350\text{mm}$

E2809.1 拉钩 Retractor  $\Phi 2.5 \times 250\text{mm}$

E2809.2 拉钩 Retractor  $\Phi 2.5 \times 250\text{mm}$

E2810 皮下注水器 Subcutaneous injector  $\Phi 2.5 \times 250\text{mm}$

E2016.14B 穿刺器 Trocar set  $\Phi 11 \times 125\text{mm}$ 磁片式(Magnet)

E2016.15B 穿刺器 Trocar set  $\Phi 6 \times 125\text{mm}$ 磁片式(Magnet)

## 腹腔镜单孔经济器械 $\Phi 5 \times 400\text{mm}$ Single port umbilical laparoscopy instruments

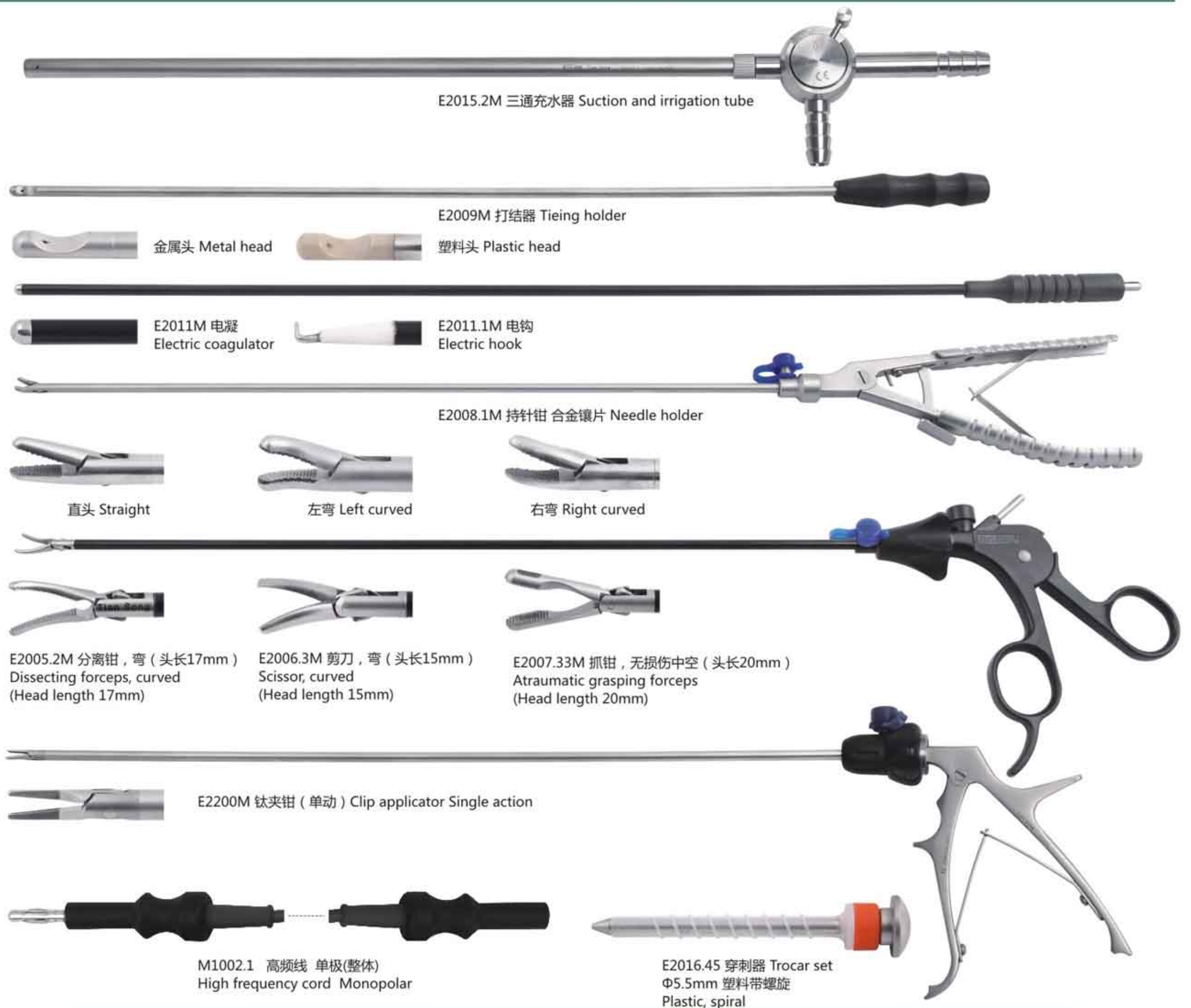

E2015.2M 三通充水器 Suction and irrigation tube

E2009M 打结器 Tieing holder

金属头 Metal head

塑料头 Plastic head

E2011M 电凝  
Electric coagulator

E2011.1M 电钩  
Electric hook

E2008.1M 持针钳 合金镶片 Needle holder

直头 Straight

左弯 Left curved

右弯 Right curved

E2005.2M 分离钳, 弯 (头长17mm)  
Dissecting forceps, curved  
(Head length 17mm)

E2006.3M 剪刀, 弯 (头长15mm)  
Scissor, curved  
(Head length 15mm)

E2007.33M 抓钳, 无损伤中空 (头长20mm)  
Atraumatic grasping forceps  
(Head length 20mm)

E2200M 钛夹钳 (单动) Clip applicator Single action

M1002.1 高频线 单极(整体)  
High frequency cord Monopolar

E2016.45 穿刺器 Trocar set  
 $\Phi 5.5\text{mm}$  塑料带螺旋  
Plastic, spiral

腹腔镜经济器械(弯型) Single port umbilical laparoscopy instruments(Curved)

E0005 腹腔镜 Endoscope 30° Φ5×302mm



Φ5×410mm



E2005.1W 分离钳, 直  
Dissecting forceps, straight



E2005.6W 分离钳 90°  
Dissecting forceps, 90° angled



E2006.2W 剪刀, 直, 单动  
Scissor, straight, Single action



E2005.2W 分离钳, 弯  
Dissecting forceps, curved



E2005.7W 抓钳, 鳄鱼型  
Fixation grasping forceps, crocodile



E2006.3W 剪刀, 弯  
Scissor, curved



E2007.8W 抓钳, 粗齿胆囊  
Gallbladder grasping forceps rough toothed



E2005.3W 分离钳 30°  
Dissecting forceps, 30° angled



E2005.8W 抓钳, 锯齿型  
Fixation grasping forceps, serrated



E2006.4W 剪刀, 钩型, 单动  
Scissor, hook, Single action



E2007.9W 抓钳, 胆囊  
Gallbladder grasping forceps



E2005.4W 分离钳 45°  
Dissecting forceps, 45° angled



E2005.9W 抓钳, 环型  
Fixation grasping forceps, loop



E2007W 抓钳  
Grasping forceps

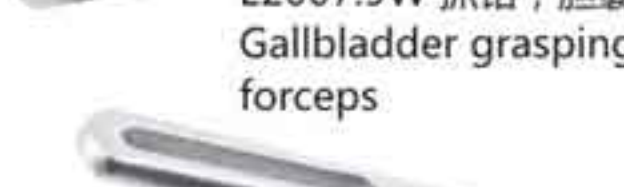

E2007.10W 抓钳, 细齿中空  
Grasping forceps



E2005.5W 分离钳 70°  
Dissecting forceps, 70° angled



E2006.1W 剪刀, 直  
Scissor, straight



E2007.5W 抓钳, 无损伤  
Atraumatic grasping forceps



钛夹钳 Clip applicator  
Φ5×410mm  
E2200W



E2008.1W 持针钳 Needle holder  
Φ5×410mm



E2011W 电凝 Electric coagulator  
Φ5×410mm



E2011.1W 电钩 Electric hook  
Φ5×410mm



E2016.45 穿刺器 Trocar set  
Φ5.5mm 塑料带螺旋  
Plastic, spiral



E2015.2W 三通充水器  
Suction & Irrigation tube  
Φ5×410mm



E2016.12 穿刺器 Trocar set  
Φ5.5mm 磁片式 Megnet



T1001 连接器 Adaptor



M1002 高频线  
High frequency cord



Top Technology  
Top Products  
Top Service



尖端科技  
尖端产品  
尖端服务

[28]

## 微型腹腔镜经济器械 Mini laparoscopy instruments



E2200 E2200.1

E2200.2



E2205 电凝 Electric coagulator  $\Phi 3 \times 330\text{mm}$

E2205.1 电钩 Electric hook  $\Phi 3 \times 330\text{mm}$

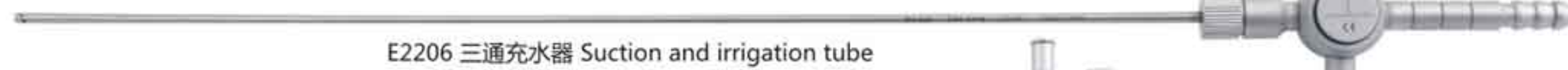

E2206 三通充水器 Suction and irrigation tube



E2017.2 转换器不锈钢 Reducer (stainless steel) 5mm/3mm



E2207 穿刺器 Trocar set 圆筒式 Cylindrical  $\Phi 3.5\text{mm}$



穿刺器, 小儿用 Pediatric trocar set  
E2207.1  $\Phi 3\text{mm}$   
E2207.2  $\Phi 5\text{mm}$

## 小切口器械 Small incision instruments



E2301 钛夹钳 Deep clip applicator  $\Phi 10 \times 220\text{mm}$



E2302 取石钳 单动 Lithotomy forceps, single action  $\Phi 10 \times 220\text{mm}$



E2303 分离钳 (头长17mm) Dissecting forceps (Head length 17mm)  $\Phi 5 \times 220\text{mm}$

E2304 剪刀, 直, 单动 (头长13mm) Straight scissor, Single action (Head length 13mm)  $\Phi 5 \times 220\text{mm}$

E2305 抓钳 (头长17mm) Grasping forceps (Head length 17mm)  $\Phi 5 \times 220\text{mm}$



E2309 三通充水器 Suction and irrigation tube  $\Phi 5 \times 220\text{mm}$



E2306 打结器 Tying holder  $\Phi 5 \times 220\text{mm}$



金属头 Metal head



塑料头 Plastic head



E2307 电钩 Electric hook  $\Phi 5 \times 220\text{mm}$



E2308 电凝 Electric coagulator  $\Phi 5 \times 220\text{mm}$



E2320 门型牵开器 Retractor



S型拉钩带照明 S hook with light  
E2311 220×24mm  
E2311.1 260×35mm  
E2311.2 340×45mm



L型拉钩带照明 L hook with light  
E2310 190×24×90mm  
E2310.1 220×35×125mm  
E2310.2 260×50×145mm  
E2310.3 260×60×150mm  
E2310.4 230×50×120mm  
E2310.5 230×60×85mm 弧形  
E2310.6 220×35×90mm 弧形

胸腔镜手术器械 Thoracoscopy instruments

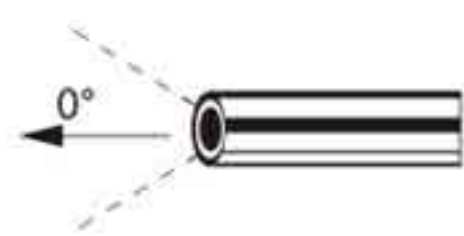

E1001.1 0°  
Φ10×230mm

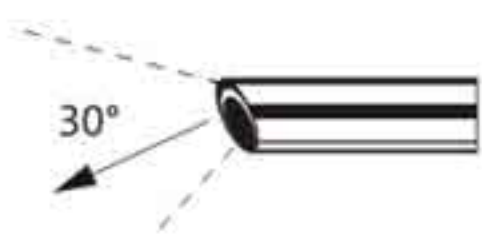

E1002.1 30°  
Φ10×230mm

1. 连接天松导光束  
Connecting to TIANSONG light guide cable
- 连接OLYMPUS导光束  
Connecting to OLYMPUS light guide cable
- 连接STORZ导光束  
Connecting to STORZ light guide cable
2. 连接WOLF导光束  
Connecting to WOLF light guide cable
3. 连接ACMI STRYKER导光束  
Connecting to ACMI, STRYKER light guide cable



胸腔镜 Thoracoscope



E2018 肺叶钳 (头长43mm)  
Lung forceps (Head length 43mm)  
Φ10×230mm



E7008 抓钳, 细齿有孔 (头长21mm)  
Grasping forceps, greeve teeth, with hole  
(Head length 21mm) Φ5×330mm



E7005 活检钳, 匙状, 直型双动 (头长13mm)  
Biopsy forceps spoon straight  
(Head length 13mm) Φ5×330mm



E7009 犬齿活检钳 (头长13mm)  
Biopsy forceps, with nail  
(Head length 13mm) Φ5×330mm

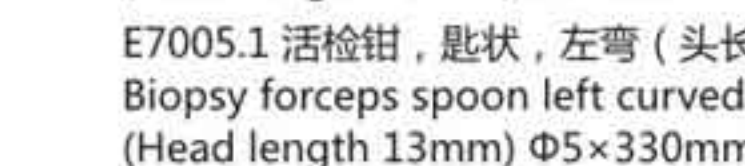

E7005.1 活检钳, 匙状, 左弯 (头长13mm)  
Biopsy forceps spoon left curved  
(Head length 13mm) Φ5×330mm



E7010 活检钳, 咬切状 (头长13mm)  
Biopsy forceps, punch, single action  
(Head length 13mm) Φ5×330mm



E7007 抓钳, 直型齿状 (头长13mm)  
Grasping forceps, straight, serrated  
(Head length 13mm) Φ5×330mm



E7011 抓钳, 无齿 (头长13mm)  
Grasping forceps, no tooth  
(Head length 13mm) Φ5×330mm

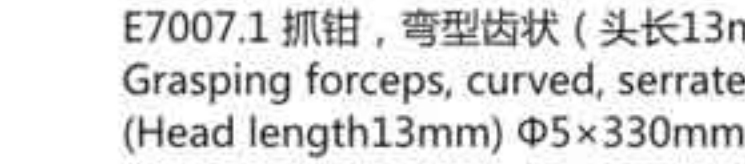

E7007.1 抓钳, 弯型齿状 (头长13mm)  
Grasping forceps, curved, serrated  
(Head length 13mm) Φ5×330mm



E2004.3 分离钳 90° (头长33mm)  
Dissecting forceps  
(Head length 33mm) Φ10×230mm



E7014 手术剪, 弯 (头长25mm)  
Scissor, curved  
(Head length 25mm) Φ10×230mm



E7024 抓钳, 食管用 (头长25mm) Esophageal forceps  
(Head length 25mm) Φ5×250mm



E7026 肺叶钳 (头长46mm) Lung tumor forceps  
(Head length 46mm) Φ5×300mm



E7018 卵圆钳 (头长100mm) Oval forceps  
(Head length 100mm) Φ10×230mm



E7006 活检钳 (匙状)左弯 单动  
Biopsy forceps (spoon left curved, single action)  
Φ10×330mm





Top Technology  
Top Products  
Top Service



尖端科技  
尖端产品  
尖端服务

[30]

## 胸腔镜手术器械 Thoracoscopy instruments



E7017 卵圆钳  
Oval forceps 250mm

E7027 直角推结钳  
Square tying forceps 300mm

肺叶钳 Lung forceps  
E2018.3 160mm  
E2018.4 180mm  
E2018.5 250mm

E7015 手术剪 Scissors 300mm

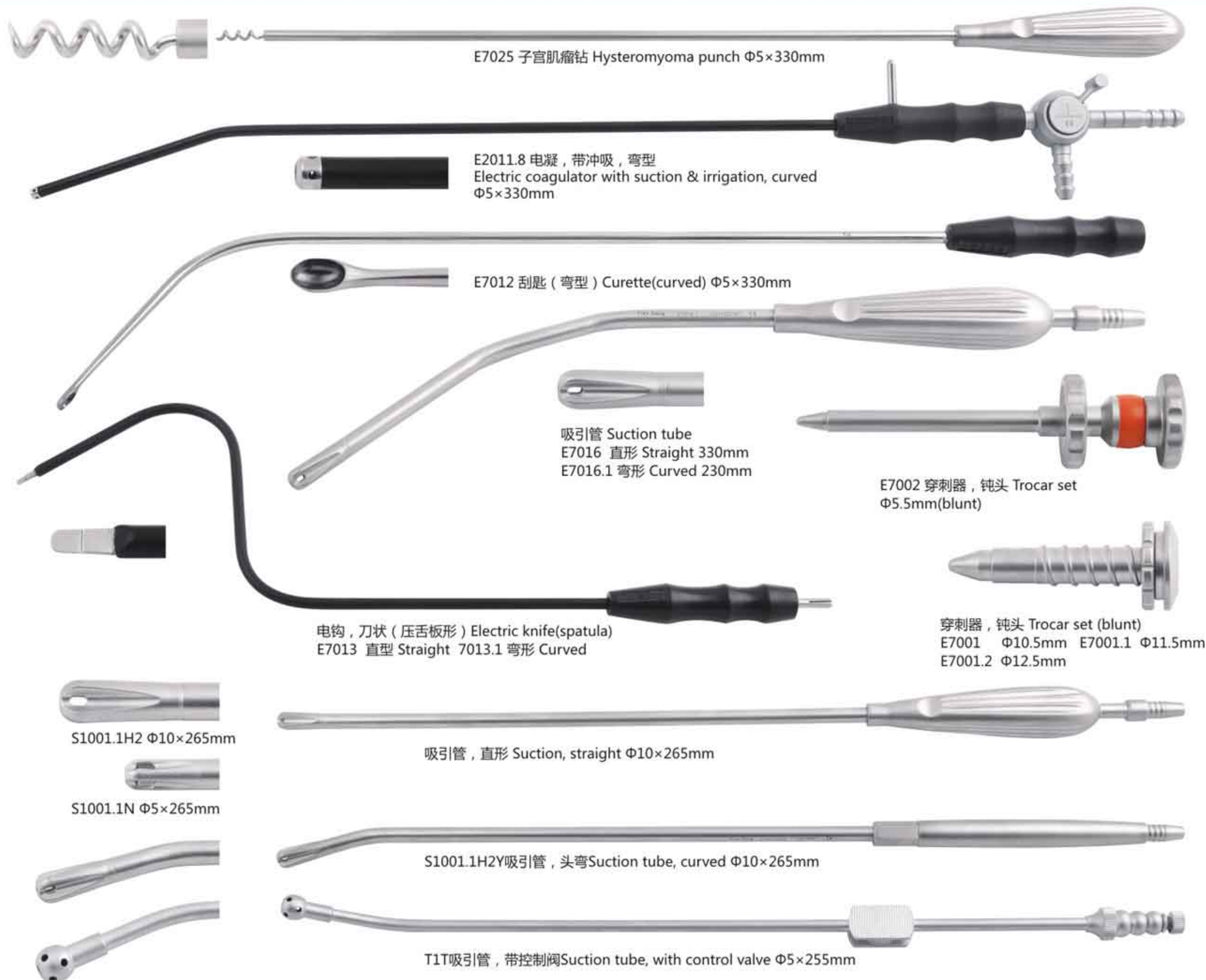

E7025 子宫肌瘤钻 Hysteromyoma punch  $\Phi 5 \times 330$ mm

E2011.8 电凝, 带冲吸, 弯型  
Electric coagulator with suction & irrigation, curved  
 $\Phi 5 \times 330$ mm

E7012 刮匙 (弯型) Curette(curved)  $\Phi 5 \times 330$ mm

吸引管 Suction tube  
E7016 直形 Straight 330mm  
E7016.1 弯形 Curved 230mm

E7002 穿刺器, 钝头 Trocar set  
 $\Phi 5.5$ mm(blunt)

电钩, 刀状 (压舌板形) Electric knife(spatula)  
E7013 直型 Straight 7013.1 弯形 Curved

穿刺器, 钝头 Trocar set (blunt)  
E7001  $\Phi 10.5$ mm E7001.1  $\Phi 11.5$ mm  
E7001.2  $\Phi 12.5$ mm

S1001.1H2  $\Phi 10 \times 265$ mm

吸引管, 直形 Suction, straight  $\Phi 10 \times 265$ mm

S1001.1N  $\Phi 5 \times 265$ mm

S1001.1H2Y吸引管, 头弯 Suction tube, curved  $\Phi 10 \times 265$ mm

T1T吸引管, 带控制阀 Suction tube, with control valve  $\Phi 5 \times 255$ mm

## 胸腔镜手术器械 Thoracoscopy instruments

双关节手术器械  
Double-jointed instruments

止血钳 Hemostatic forceps  $\Phi 5 \times 330\text{mm}$   
E7028 弧弯高 15mm  
E7028.1 弧弯高 20mm  
E7028.2 弧弯高 25mm  
E7028.3 直角高 25mm  
E7028.4 游离钳 Free forceps



卵圆钳 Oval forceps  $\Phi 5 \times 330\text{mm}$   
E7029 头宽 有齿 8mm  
E7029.5 头宽 有齿 12mm  
E7029.6 头宽 有齿 10mm  
E7029.7 头宽 无齿 8mm  
E7029.8 头宽 无齿 10mm  
E7029.9 头宽 无齿 12mm



活检钳 (淋巴) Biopsy forceps (lymph)  
E7030  $\Phi 5 \times 330\text{mm}$



手术剪 Scissor  
E7031 直, straight  
E7031.1 弯, curved



抓钳 Grasping forceps  
E7032 直头8mm, straight  
E7032.1 弯头8mm, curved



持针钳 Needle holder  
E7033 直 straight  
E7033.1 弯 curved



吸引管 Suction  
E7034 直, straight  
E7034.1 弯, curved



吸引管 Suction  
E7035 直, straight  
E7035.1 弯, curved



Top Technology  
Top Products  
Top Service



尖端科技  
尖端产品  
尖端服务

[32]

## 胸腔镜手术器械 Thoracoscopy instruments

### 双关节手术器械 Double-jointed instruments



E2018A6G 肺叶钳  
Lung forceps  $\Phi 5 \times 300\text{mm}$

E2005.8A 持针钳  
Needle holder  $\Phi 5 \times 230\text{mm}$



E2005.3G 止血钳 Hemostatic forceps 弯  
 $\Phi 5 \times 250\text{mm}$

E2005.3G2 止血钳 Hemostatic forceps  
 $\Phi 5 \times 270\text{mm}$



E2005.3G4 止血钳 Hemostatic forceps  
 $\Phi 5 \times 270\text{mm}$

E2005.5G 止血钳 Hemostatic forceps  
弯/90°  $\Phi 5 \times 230\text{mm}$



E31104.1 手术剪, 直 Straight scissor  
 $\Phi 5 \times 250\text{mm}$

E31104.2B 手术剪, 弯 Scissor, curved  
 $\Phi 5 \times 250\text{mm}$



E2005.11AUC 医用镊, 止血用头弯  
Hemostatic forceps, curved

E2005.12K1 医用镊, 淋巴头弯  
Lymph tweezers, curved  $\Phi 10\text{mm}$

高频线 High frequency cord





Top Technology  
Top Products  
Top Service



尖端科技  
尖端产品  
尖端服务

[34]

## ZCX型自动冲洗吸引泵 Automatic suction and rinsing apparatus

E2104 吸引瓶 2000ml  
Suction bottle

E2100 自动冲洗泵主机大于1升/分  
Control unit 3 litre/min

E2103 排液针 185mm  
Liquid ejection needle



## 金手指 Golden finger



## 可弯套扎钳 Ligation forceps



## 可转弯腹腔镜手术器械 Laparoscope instruments, flexible head $\Phi 10 \times 330\text{mm}$



CJ-1乙状镜 Sigmoidoscope set



乙状镜 Sigmoidoscope  
H1001  $\Phi 20 \times 300$ mm  
H1002  $\Phi 15 \times 300$ mm  
H1003  $\Phi 20 \times 230$ mm



H0001 显微镜 Magnifier

CJ-2直肠镜 Rectoscopy set



直肠镜 Rectoscopy  
H1001.1  $\Phi 20 \times 150$ mm  
H1001.2  $\Phi 15 \times 150$ mm



H0001 显微镜 Magnifier

CJ-3乙状镜 Sigmoidoscope set



乙状镜 Sigmoidoscope  
H1004  $\Phi 20 \times 267$ mm

A0011 12° 内窥镜 Endoscope  $\Phi 4 \times 302$ mm

H1005 操作器 Manipulator  $\Phi 17 \times 279$ mm

F2101 内窥镜软钳 Flexible biopsy forceps  $\Phi 2.4 \times 395$ mm

CJ-1、CJ-2、CJ-3乙状镜直肠镜通用件 Sigmoidoscope & Rectoscopy set interchangeable parts



H2005 棉球夹 Cotton applicator

H2001 活检钳 直  
Biopsy forceps, straight

H2002 活检钳 左弯  
Biopsy forceps, left curved

H2003 活检钳 右弯  
Biopsy forceps, right curved

H2004 活检钳 切除式  
Biopsy forceps, Dissecting

H2006 鼓气球  
Hand inflating ball



Top Technology  
Top Products  
Top Service



尖端科技  
尖端产品  
尖端服务

36

## GQ-6型宫腔镜 Hysteroscopy set

F0107 0° 子宫腔内窥镜  
Hysteroscopy  $\Phi 6.6 \times 220\text{mm}$   
F0108 0° 子宫腔内窥镜  
Hysteroscopy  $\Phi 5.3 \times 224\text{mm}$

F0101.1 22° 子宫腔内窥镜  
Hysteroscopy  $\Phi 6.6 \times 220\text{mm}$   
F0106 22° 子宫腔内窥镜  
Hysteroscopy  $\Phi 5.3 \times 220\text{mm}$

1. 连接天松导光束  
Connecting to TIANSONG light guide cable  
连接OLYMPUS导光束  
Connecting to OLYMPUS light guide cable  
连接STORZ导光束  
Connecting to STORZ light guide cable
2. 连接WOLF导光束  
Connecting to WOLF light guide cable
3. 连接ACMI STRYKER导光束  
Connecting to ACMI, STRYKER light guide cable



内窥镜软钳 Flexible operating forceps  $\Phi 2.4 \times 395\text{mm}$



F2101 活检状  
Biopsy forceps



F2102 剪刀状  
Scissor



F2107 取环状  
Loop catching forceps



F2108 剪刀状  
Scissor

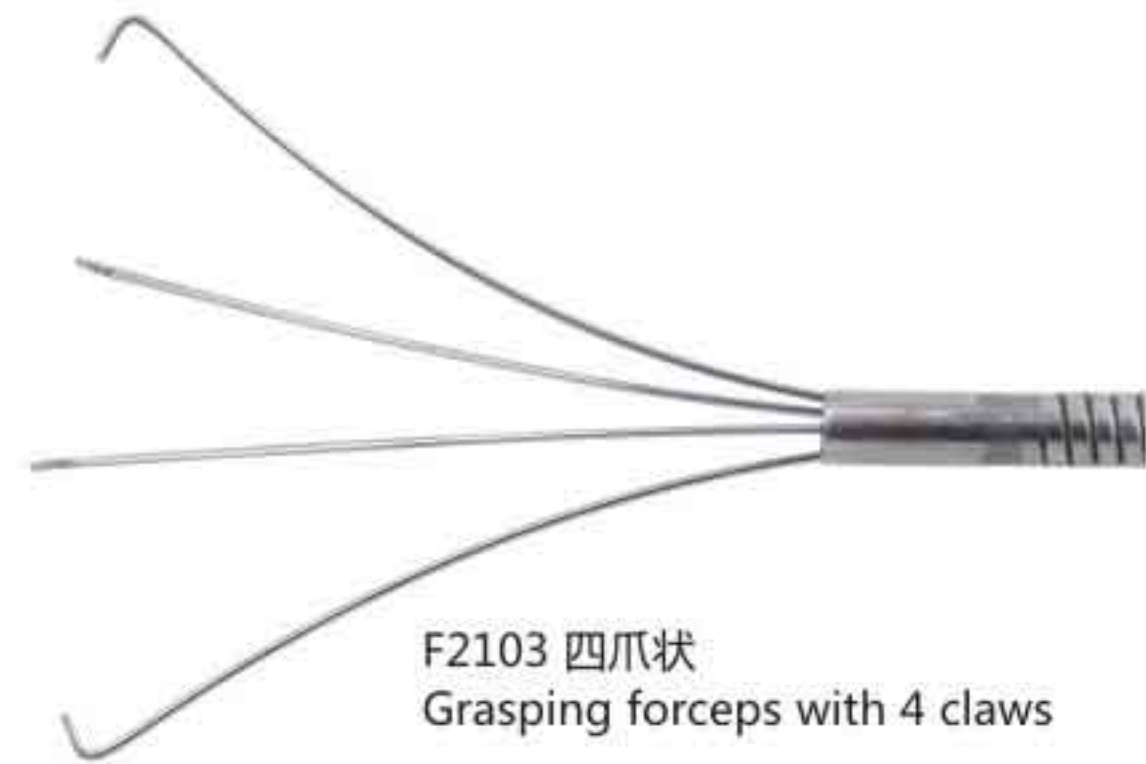

F2103 四爪状  
Grasping forceps with 4 claws



毛刷, 软性 Brush flexible  
F2104  $\Phi 2.4 \times 360\text{mm}$   
F2104.1  $\Phi 1.8 \times 320\text{mm}$



F2104 毛刷, 硬性 Brush rigid  $\Phi 2.5 \times 360\text{mm}$



F4001.2 长针 long needle



A2145 密封帽 Sealing cap



F4001 膨宫加压器装置 (配输液器、长针)  
Fluid control uteromat(with Infusion device and long needle)



F4002 膨宫加压器装置 (电脑全自动)  
Fluid control uteromat(Automatic)



F4001.1 输液器 (一次性)  
Infusion device (Disposable)



T5010 导光束 light guide cable  
 $\Phi 4.5 \times 2000\text{mm}$

GQ-3型宫腔镜 Hysteroscopy set

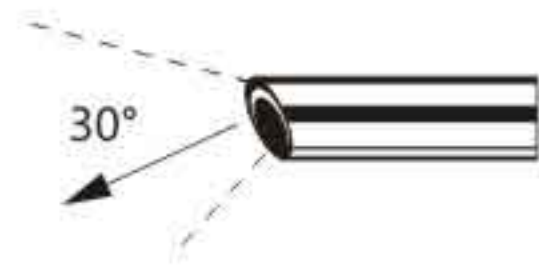

A0012 30° 内窥镜 Endoscope  
Φ4×302mm



F1115 操作鞘套 24Fr 循环灌流 Operating sheath



F1117.3 操作器 Manipulator



F1116.3 外鞘 Outer sheath 30° 21Fr



A2101.1 活检钳 硬性  
Biopsy forceps Rigid  
7Fr×395mm



A2104.1 剪刀 硬性  
Scissor Rigid  
7Fr×395mm



F2107.3 取环钳 硬性  
Loop catching forceps Rigid  
7Fr×395mm

GQ-8型宫腔镜 (检查) Hysteroscopy set (Examine)



T1009.1 进水阀门 Luer-lock adaptor



T1001 连接器 Adaptor

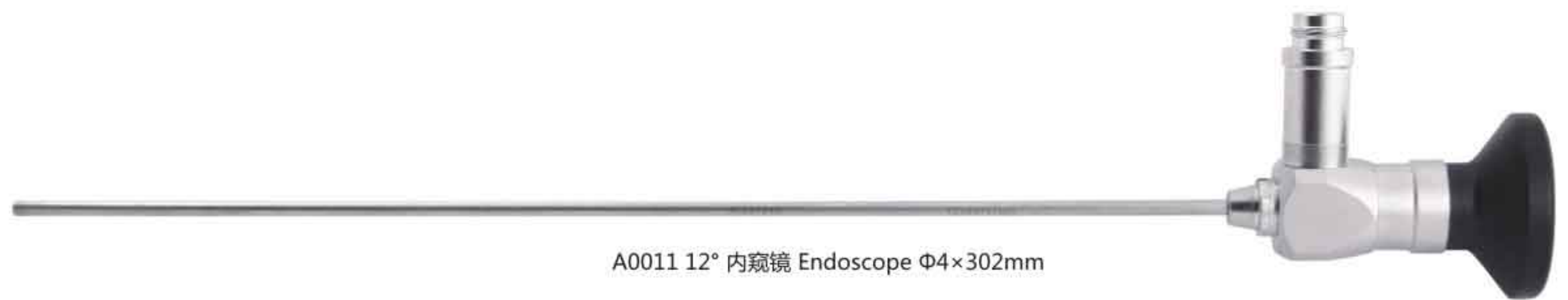

A0011 12° 内窥镜 Endoscope Φ4×302mm



F1101 外鞘 Outer sheath 19.5Fr



T5010 导光束 Light guide cable  
Φ4.5×2000mm



F1102 内鞘 inner sheath 16.5Fr



Top Technology  
Top Products  
Top Service



尖端科技  
尖端产品  
尖端服务

38

## GQ-10型宫腔镜 (检查) Hysteroscopy set (Examine)



## GQ-11型宫腔镜 Hysteroscopy set

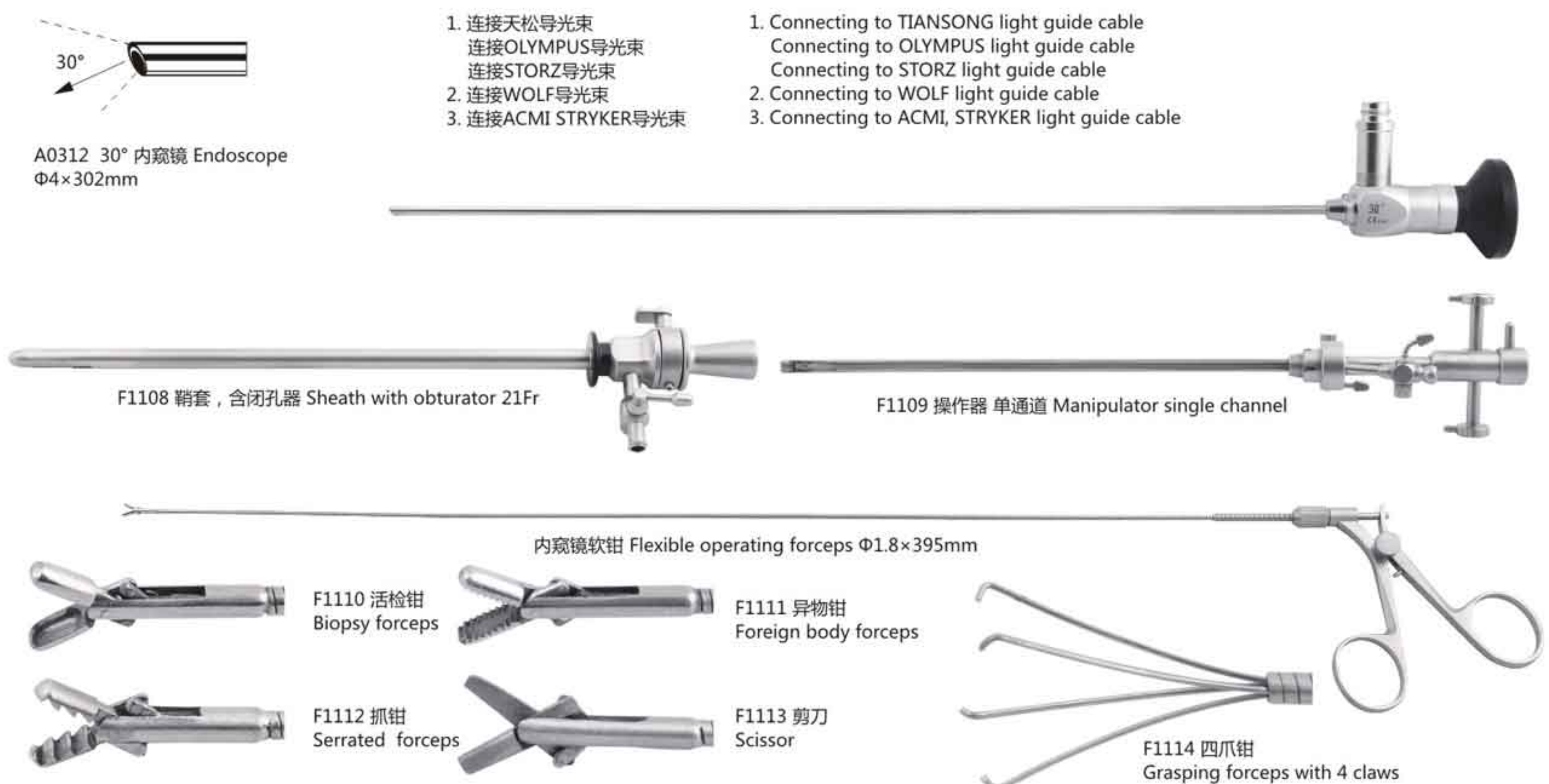

## GQ-12型宫腔镜 Hysteroscopy set

A0022 30° 内窥镜 Endoscope  
Φ2.9×302mm

F1117 操作器 Manipulator 锁扣 配Φ3mm 内窥镜



F1116 外鞘 Outer sheath 锁扣 30° 16.5Fr×200mm



F1117.1 操作器 Manipulator 卡扣 配Φ3mm 内窥镜



F1116.1 外鞘 Outer sheath 卡扣 30° 16.5Fr×200mm





Top Technology  
Top Products  
Top Service



尖端科技  
尖端产品  
尖端服务

[40]

## GQ-15型宫腔镜 Hysteroscopy set



## GQ-16型宫腔镜 Hysteroscopy set



## GQ-12、15、16宫腔镜通用件 Hysteroscopy set interchangeable parts



DQ-5型电切镜 Resectoscopy set



A0011 12° 内窥镜  
Endoscope  
Φ4×302mm

1. 连接天松导光束  
连接OLYMPUS导光束  
连接STORZ导光束
2. 连接WOLF导光束
3. 连接ACMI STRYKER导光束

1. Connecting to TIANSONG light guide cable  
Connecting to OLYMPUS light guide cable  
Connecting to STORZ light guide cable
2. Connecting to WOLF light guide cable
3. Connecting to ACMI,STRYKER light guide cable



A0011 12° 内窥镜 Endoscope Φ4×302mm



A3162 工作把手 (被动式)  
Working element (Passive)



A3163.2 内鞘, 含闭孔器 Inner sheath with obturator 22Fr



A3165.2 外鞘 Outer sheath 25.5Fr



手机电极 Electrode



A3111 环状  
Loop



A3122 滚状  
Roller



A3114 直状  
Straight loop



T1009.1 进水阀门 Luer-lock adaptor



T1001 连接器 Adaptor



M0015 高频发生器 (多功能型)  
H.F. Generator(Multifunction)



M1001 高频线 (单极)  
High frequency cord (Monopolar)



T5010 导光束  
Light guide cable  
Φ4.5×2000mm



Top Technology  
Top Products  
Top Service



尖端科技  
尖端产品  
尖端服务

[42]

## 电动子宫切除器 Electric hystera-cutter



F5002 控制箱 Control unit

F3002.2 电动装置  
Hand piece



切割刀具, 腹式 Abdominal cutter  
F2012.1  $\Phi 10 \times 260\text{mm}$  F2012.2  $\Phi 15 \times 260\text{mm}$   
F2012.7  $\Phi 18 \times 260\text{mm}$  F2012.8  $\Phi 20 \times 260\text{mm}$



穿刺器套管 Trocar cannula  
F2013  $\Phi 20\text{mm}$  F2023  $\Phi 15\text{mm}$  F2026  $\Phi 18\text{mm}$



切割刀具, 阴式 Vagina cutter  
F2012.3  $\Phi 18 \times 260\text{mm}$  F2012.4  $\Phi 20 \times 260\text{mm}$   
F2012.5  $\Phi 22 \times 260\text{mm}$  F2012.6  $\Phi 15 \times 260\text{mm}$



穿刺器套管 Trocar cannula  
F3023  $\Phi 15\text{mm}$  F3026  $\Phi 18\text{mm}$



F2009 举宫器 Uterine manipulator



扩张器 Dilator  
F2014  $\Phi 10/\Phi 20\text{mm}$  F2024  $\Phi 10/\Phi 15\text{mm}$   
F2028  $\Phi 10/\Phi 18\text{mm}$



F2011 子宫拔棒 Uterine moving bar  $\Phi 5 \times 450\text{mm}$



扩张器 Dilator  
F3024  $\Phi 15 \times 200\text{mm}$  F3028  $\Phi 18 \times 200\text{mm}$



F2016 引导棒 Guiding bar 10mm



转换器 Reducer  
F2015  $\Phi 20/\Phi 10\text{mm}$  F2025  $\Phi 15/\Phi 10\text{mm}$   
F2025.1  $\Phi 15/\Phi 5\text{mm}$  F2027  $\Phi 18/\Phi 10\text{mm}$   
F2031  $\Phi 10/\Phi 5\text{mm}$



子宫肌瘤钻 Hysteromyoma punch  
F2017 10mm F2018 5mm



F2010 子宫深度测量棒 Hysterometer  $\Phi 5 \times 500\text{mm}$

电动子宫切除器 Electric hystera-cutter

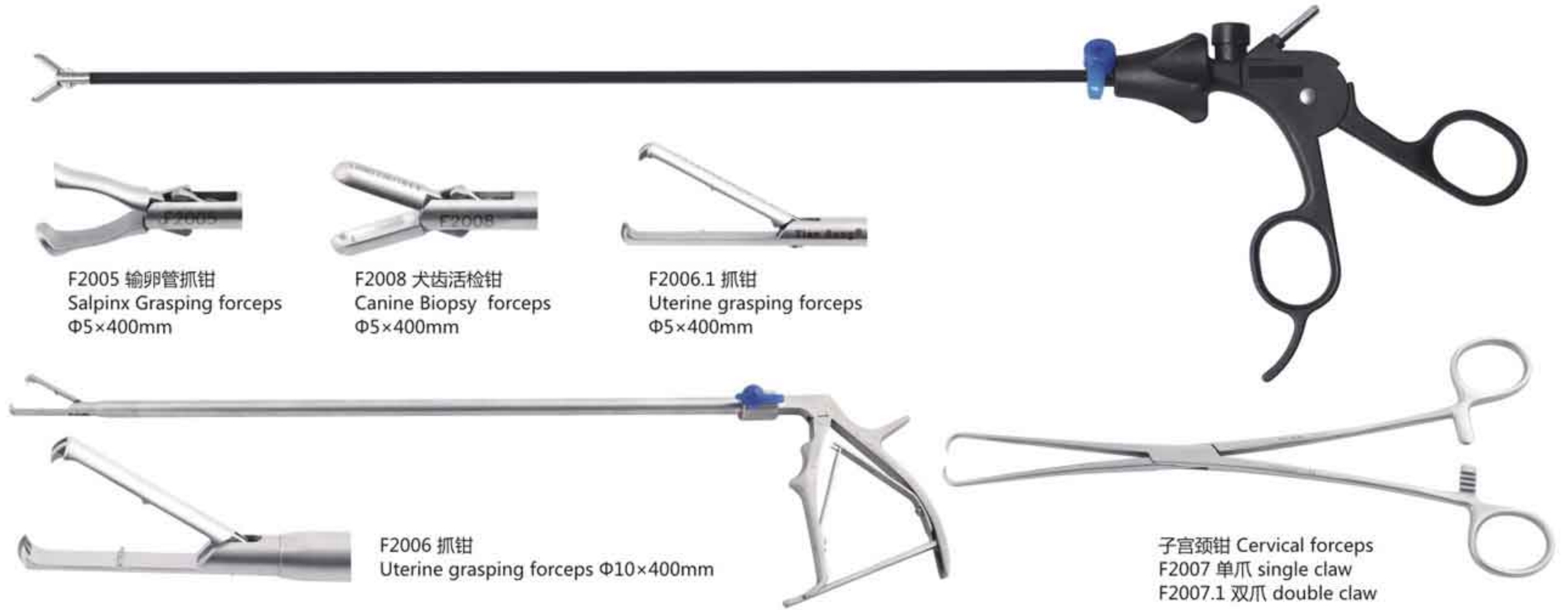

F2005 输卵管抓钳  
Salpinx Grasping forceps  
Φ5×400mm

F2008 犬齿活检钳  
Canine Biopsy forceps  
Φ5×400mm

F2006.1 抓钳  
Uterine grasping forceps  
Φ5×400mm

F2006 抓钳  
Uterine grasping forceps Φ10×400mm

子宫颈钳 Cervical forceps  
F2007 单爪 single claw  
F2007.1 双爪 double claw

妇科手术器械 Gynecology instruments



阴道拉钩 Vaginal tractor  
F2029.2 27×70mm  
F2029.3 30×80mm  
F2029.4 36×90mm  
F2029.6 36×110 mm  
F2029.7 30×110 mm  
F2029.8 27×110 mm  
F2029.9 21×110 mm  
F2029.10 15×110 mm

阴道拉钩 Vaginal tractor  
F2040.1 130×20mm  
F2040.2 130×25mm  
F2040.3 130×30 mm  
F2040.4 130×35 mm  
F2040.5 130×40 mm  
F2040.6 160×30 mm  
F2040.7 160×40 mm  
F2040.8 160×45 mm

阴道拉钩 Vaginal tractor  
F2041.1 45×115mm  
F2041.2 45×85mm  
F2041.3 45×55 mm



F2030 肌瘤剥离器 320mm  
Hysteromyoma dissector

F2035 宫颈压板 Cervical plate 250mm

F2036 阴道压板 Vaginal plate 250mm

简易举宫器 Simple uterine manipulator 250mm  
F2009.1 单爪 Single claw  
F2009.2 双爪 Double claw

F2032 韧带钩型钳 Ligamenta hook forceps

F2034 肌瘤抓钳 Myoma grasping forceps



Top Technology  
Top Products  
Top Service



尖端科技  
尖端产品  
尖端服务

[44]

妇科手术器械 Gynecology instruments



阴道镜  
Vaginal speculum  
F2042.1 35\*100mm  
F2042.2 35mm\*85mm  
F2042.3 32mm\*75mm



F2039 宫颈息肉钳 210mm  
Cervical polyp forceps



肌瘤剥离器, 双头 Myoma elevator, double heads  
F2037  $\Phi$ 10 $\times$ 400mm F2037.1  $\Phi$ 5 $\times$ 400mm



F2004 输卵管提取钩  $\Phi$ 5.8 $\times$ 350mm  
Oviduct ligature forceps



F2019.1 举宫器, 可调式, 一柄六头  
Adjustable uterine manipulator, with 6 heads



举宫杯1 Cup1

F2033 举宫器, 杯式 Cup uterine manipulator,  
三头可换 3heads



举宫杯2 Cup2



举宫头 Head



子宫固定螺旋杆1  
Uterine Fixing screw stem1



子宫固定螺旋杆2  
Uterine Fixing screw stem2



加力杆 Afterburner



举宫杯3 Cup3



手柄 Handle



举宫架 Holder



引导棒 Guiding bar

妇科手术器械 Gynecology instruments





Top Technology  
Top Products  
Top Service



尖端科技  
尖端产品  
尖端服务

46

## 内窥镜图像显示仪 Endoscopy Camera System

### NT-501型内窥镜图像显示仪

01. CCD彩色摄像机, F-168D, 480线。
02. 特制防水光学接口, F=23mm。
03. 工作台车。
04. 主机, Intel/2G内存/500G硬盘/DVD刻录机。
05. 显示器, 19寸宽屏液晶。
06. 打印机, HP4800DPI,高分辨率打印。
07. 脚踏开关。
08. 视频捕捉卡, 进口飞利浦芯片全通道色彩采样, 最高级别的图像质量。高清晰数码DVD级, 可实现影像数码动态放大, 各种动态滤波处理。
09. 图文软件, 可直接实现动态录像DVD回放/刻录, 图文打印, 最新XP系统。丰富的模板/词库/图库, 强大的病历管理功能。
10. 系统视频教学, 整套产品的视频全面教学, 对本系统操作的无师自通视频教学, 教学医师如何采集图像, 录像, 打印专业级报告。
11. 系统自动恢复, 可在20分钟快速恢复, 并对所以资料完好保存。



### NT-618型内窥镜图像显示仪 (防水型液晶屏)

01. 纯医用摄像机(液晶屏)单晶片618, 480线日本原装可浸泡消毒摄像头。
02. 特制防水光学接口。
03. 15"SONY监视器或者17"三星监视器。
04. 专用仪器车, 带多功能架。

### Endoscopy Camera System (Water Proof,LCD Panel)

01. 618 Single chip medical camera (LCD Panel), 480lines, immersible camera lens from Japan.
02. Coupler, Water Proof
03. 15"SONY or 17"SAMSUNG Monitor
04. Pushcart, with multifunctional shelf



### Endoscope Camera Documentation System

01. F-168D CCD camera,480lines
02. Coupler ,F23, Water Proof
03. Pushcart, with multifunctional shelf
04. Computer, Intel/2G/500G/DVD Recorder
05. Monitor, 19"LCD
06. Printer, HP4800DPI, high resolution print
07. Foot pedal
08. Video capture card, PHILIPS chip highest quality of image, HD digital DVD level, dynamic magnification, dynamic filter processing
09. Software, can make DVD replay /record, print, many template/word/stock/photo stock, powerful function of case management
10. Video teaching of the system, comprehensive teaching of the whole system
11. Automatic system recovery, fast recovery to factory setting in 20mins

### NT-638型内窥镜图像显示仪(三晶片防水型液晶触摸屏)

01. 纯医用3CCD摄像机(液晶屏)三晶片638, 800线日本原装可浸泡消毒摄像头。
02. 特制防水光学接口。
03. 21"SONY监视器或者15"JVC彩色监视器。
04. 专用仪器车, 带多功能架。

### Endoscopy Camera System (Water Proof,LCD Panel)

01. 638 Three chip medical camera 800lines, immersible camera lens from Japan
02. Coupler, Water Proof
03. 21"SONY or 15"JVC Monitor
04. Pushcart, with multifunctional shelf



### NT-668型内窥镜图像显示仪(防水型,高清)

01. 668型高清摄像机, 1080P, 日本原装可浸泡消毒摄像头。
02. 特制防水光学接口。
03. 26" Panasonic 高清监视器。
04. 专用仪器车, 带多功能架。

### NT-668 Endoscopy Camera System(Water Proof, HD)

01. 668HD medical camera, 1080P, immersible camera lens from Japan
02. Coupler, Water Proof
03. 26" Panasonic medical HD monitor
04. Pushcart, with multifunctional shelf



内窥镜图像显示仪 Endoscopy Camera System

NT-668A型图像显示仪

1. 全高清摄像机，液晶屏，1080P，可浸泡消毒摄像头
2. 防水光学接口（可选配变焦光学接头）
3. 24寸专用医用监视器（可选配27寸监视器）
4. LED冷光源
5. 专用仪器车，带抽屉、插线板

Endoscope camera system

1. Full-HD camera, LCD screen, 1080P, immersible camera head for disinfection
2. Water proof coupler (Zoom coupler is optional)
3. 24 inch medical monitor (27 inch monitor is optional)
4. LED cold light source
5. Trolley with drawer and patch board



NT-268A型图像显示仪

1. 高清摄像机，1080P，可浸泡消毒摄像头
2. F14防水光学接口
3. 24寸专用医用监视器
4. LED冷光源
5. 专用仪器车，带抽屉、插线板

Endoscope camera system

1. HD camera, 1080P, immersible camera head for disinfection
2. F14 Water proof coupler
3. 24 inch medical monitor
4. LED cold light source
5. Trolley with drawer and patch board



监视器 Surveillance Monitor



A2502.16 索尼15寸监视器 Sony, 15 inch  
A2502.10 索尼21寸监视器 Sony, 21 inch  
A2502.22 索尼24寸高清监视器 Sony, 24 inch, High definition



A2502.18 松下26寸高清监视器  
Panasonic, 26inch, High definition



A2502.23 巴可26寸高清监视器  
Barco, 26inch, High definition



A2502.25 国产24寸高清监视器  
24 inch, made in China



A2502.24 国产凯影24寸高清监视器  
Caring, 24inch, High definition, made in China  
A2502.26 国产凯影15寸监视器  
Caring, 15inch, made in China



Top Technology  
Top Products  
Top Service



尖端科技  
尖端产品  
尖端服务

[48]

## 摄像机 Camera system



A2500f 618  
防水型 单晶片 液晶屏  
Single chip, water proof, LCD panel



A2500e 638  
防水型 三晶片 液晶屏 触摸  
Three chip, water proof, LCD touch panel



A2500H 668  
防水型 高清(1080P)液晶触摸屏  
Water proof, HD(1080P) LCD touch panel  
A2500P 高清摄像机 HD camera system668(1080P) ,  
支持U盘存储1080P录像和图片668(1080P)  
USB flash disk support for storage of 1080P video and images  
A2500Q 高清摄像机 HD camera system668(3COMS,1080P) ,  
支持U盘存储1080P录像和图片668(3COMS,1080P)  
USB flash disk for storage of 1080P video and images



A2500J 单晶片摄像机068  
A2500K 单晶片摄像机168  
A2500L 单晶片摄像机268

配纤维镜 Single chip. for fiberscope

## 光学接口 Coupler

直通式光学接口  
Coupler, Straight



货号 Code	焦距规格 Focal length
A2513.1	F18
A2512.3	F22
A2513.3	F25
A2512.1	F27
A2517	F28
A2512.5	F32
A2512.6	F35

## 冷光源 Cold light source



LED 医用冷光源  
T5040 LL-100 , 30W  
T5040.1 LL-150 , 80W



T5001 PL-150 卤素双灯 150W  
PL-150 Halogen, double lamps 150W



氙灯 Xenon  
T5002 GL-350B 350W  
T5002.1 GL-350E 350W



T5004 PL-300 卤素双灯 250W  
PL-300 Halogen, double lamps



T5007.6 微型冷光源(带充电器)  
Portable cold light source (with charger)  
T5007.7 带硅胶套 With silica gel set



T5002.5 GL-300氙灯 180W  
GL-300 Xenon 180W

导光束示意图 Light guide cable diagram

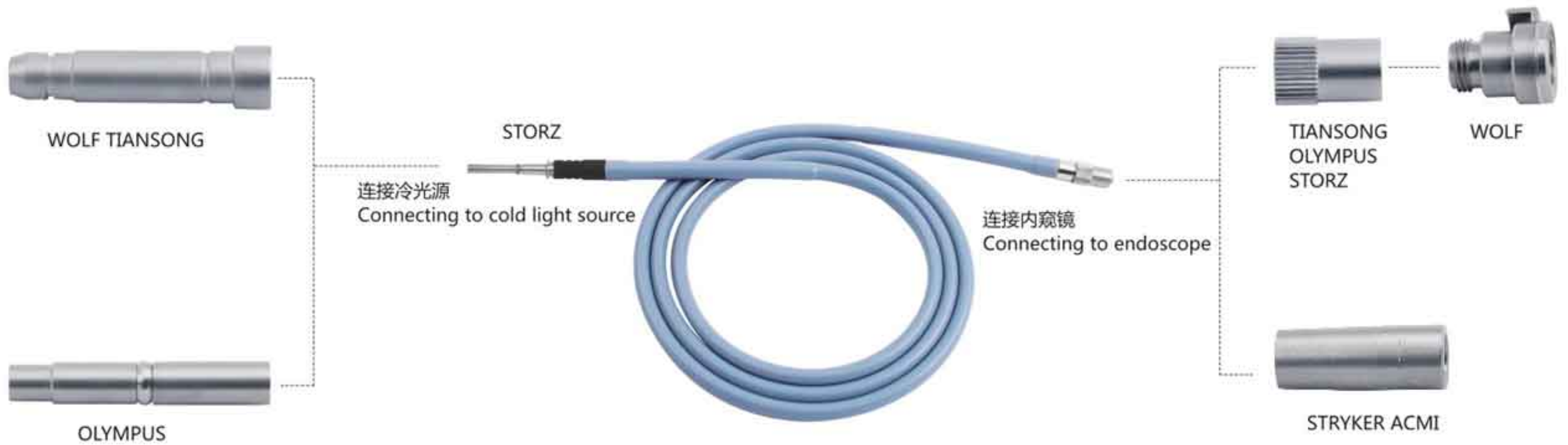

- T5010 Φ4.5×2000mm
- T5010.1 Φ4.5×1800mm
- T5010.2 Φ4.5×2000mm 耐高温高压 Autoclave
- T5010.3 Φ4.5×2000mm 耐等离子, plasma
- T5012 Φ4.5×1800mm
- T5013 Φ1.8×1700mm
- T5014 Φ2.5×1700mm
- T5016.1 双头 Φ1.8-Φ2.5 double head
- T5017 双头 Φ2.5 double head
- T5018.2 Φ4.5×2300mm 耐等离子, plasma
- T5018 Φ4.5×2300mm
- T5018.1 Φ4.5×2300mm 耐高温高压 Autoclave
- T5020 Φ4.5×2500mm
- T5020.2 Φ4.5×2500mm 耐高温高压 Autoclave
- T5020.3 Φ4.5×2500mm 耐等离子, plasma

- T5021 Φ4.5×3000mm
- T5021.1 Φ4.5×3500mm
- T5021.2 Φ4.5×3500mm 耐高温高压 Autoclave
- T5021.3 Φ4.5×3000mm 耐等离子, plasma
- T5022 Φ5×2500mm
- T5023 Φ5×3000mm
- T5023.1 Φ5×3000mm 耐高温高压 Autoclave
- T5023.3 Φ4.5×3000mm 耐等离子, 螺旋管, plasma
- T5023.5 Φ5×3000mm 耐等离子, plasma
- T5024 Φ5×3000mm 连接 OLYMPUS
- T5024.1 Φ5×3000mm 连接 OLYMPUS 耐高温高压 Autoclave
- T5024.2 Φ5×3000mm 连接 OLYMPUS 耐等离子, plasma

连接器 Adaptor



T1003 内窥镜接口 配WOLF内窥镜  
Adaptor, for WOLF endoscope



T1004 光源端插头外套 配WOLF天松冷光源  
Adaptor, for WOLF, TIANSONG cold light source



T1005 光源端插头外套 配OLYMPUS冷光源  
Adaptor, for OLYMPUS cold light source



T1006 光缆接头 配STRYKER导光束插头端  
Adaptor, for STRYKER light guide cable



T1007 光缆接头 配ACMI导光束插头端  
Adaptor, for ACMI light guide cable



T1008 内窥镜接头 配ACMI STRYKER内窥镜  
Adaptor, for ACMI, STRYKER endoscope

附属设备



E2151 CO<sub>2</sub>气腹机30升/分  
CO<sub>2</sub> Insufflator 30L/min



F4002 膨宫加压器装置 (电脑全自动)  
Fluid control uteromat(Automatic)



F4003 灌注泵 Irrigation pump  
流量0.1-1升/分 Flow rate : 0.1-1L/min



Top Technology  
Top Products  
Top Service



尖端科技  
尖端产品  
尖端服务

[50]

## 医用器械消毒盒 Medical instruments sterilizing box



A0000.1 膀胱镜消毒盒  
For Cystoscopy set  
530×230×90mm



A0000.2 电切镜消毒盒  
For Resectoscope set  
420×275×90mm



B0000.3 鼻窦手术器械消毒盒  
For Sinuscopy instruments  
380×210×70mm



B0000.2 鼻窦镜消毒盒  
For Sinuscopy set  
360×255×90mm



F0000 电动子宫切割器消毒盒  
For electric hystera-cutter  
560×275×140mm



190001000 内窥镜、器械通用  
Endoscope Instruments in common use  
550×245×70mm



A0000.5 输尿管肾镜消毒盒  
Sterilizing box for Ureterorenoscopy  
720×120×70mm



A0000.7 膀胱镜消毒盒  
For Cystoscopy set  
390×80×52mm,网状 nets



F0000.1 举宫杯消毒盒  
Sterilizing box for Uterine manipulator  
500×180×70mm,网状 nets



F0000.2 宫腔镜消毒盒  
Sterilizing box for Hysteroscopy  
720×120×55mm,网状 nets



E0000.3 腹腔镜消毒盒  
Sterilizing box for Laparoscopy  
460×80×52mm,网状 nets



E0000.4 网状消毒盒  
reticular sterilizing box  
100×100×55mm,网状 nets



190001000a 通用消毒盒  
Endoscope Instruments in common use  
550×245×70mm



B0000 内窥镜消毒盒  
For endoscope  
280×70×50mm



B0000.5 内窥镜消毒盒(耐高温高压)  
For endoscope, autoclavable  
255×71×36mm



E0000A 腹腔镜消毒盒  
For laparoscope  
450×90×45mm

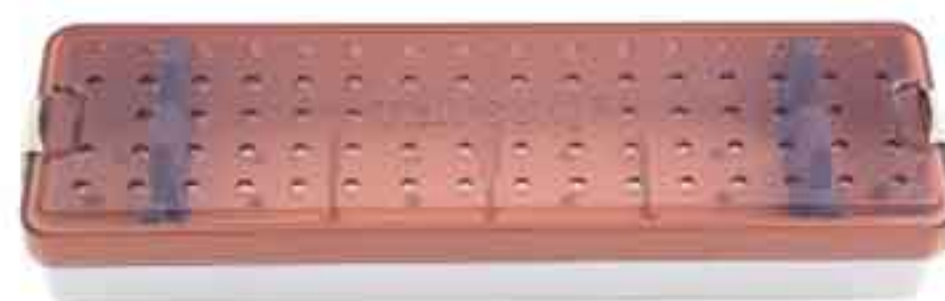

B0000.4 内窥镜消毒盒  
For endoscope  
255×71×36mm



A0000.4 内窥镜消毒盒(耐高温高压)  
For endoscope, autoclavable  
390×71×36mm